

m
Materasso

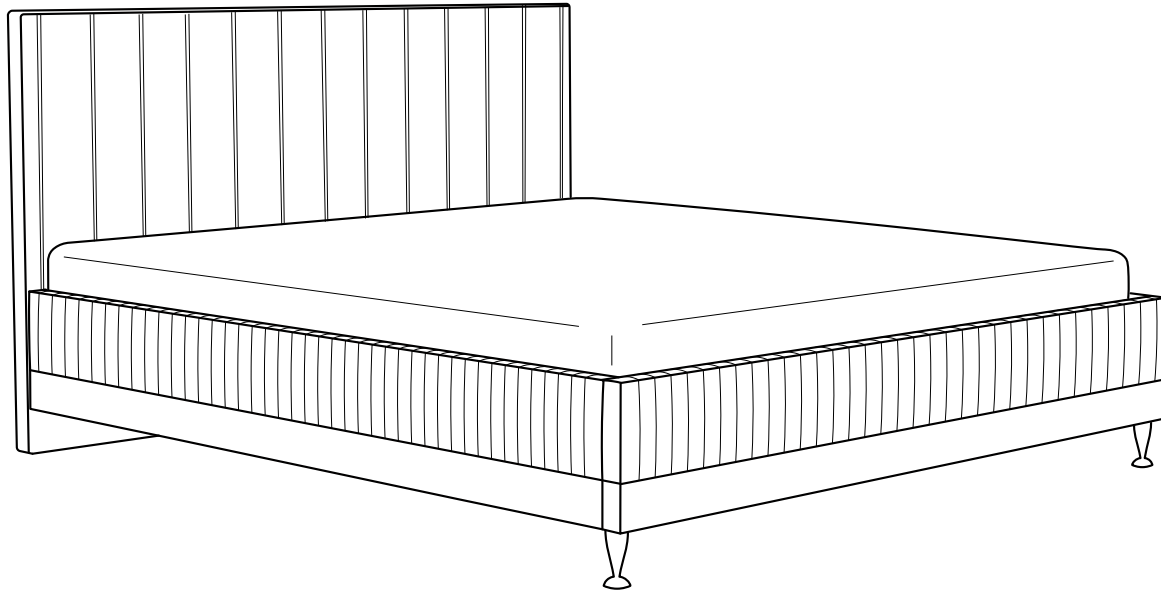

SK

m
Materasso
Pre chvíle, na ktorých záleží...



- 15 DAMIANI SET
- 17 CRISTAL SET
- 19 SPECTRA SET
- 21 CORONA SET
- 23 FRANCESCA LUX SET
- 25 SOUL SET

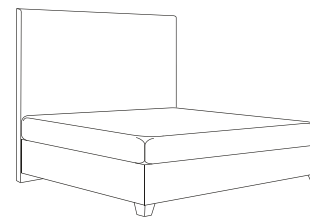

- 26 MONZANO
- 28 LINORA
- 31 ENZO
- 33 SANDRO
- 35 CHESS
- 37 ZINA
- 39 DUNA
- 41 CRISTAL
- 43 LA SPEZIA
- 45 DAMIANI
- 47 SOUL
- 49 CORIUM
- 51 FOREST
- 53 CHESTERFIELD
- 55 RHOMBUS
- 57 WILD
- 59 KINGSTONE
- 61 HONEY

- 62 MELVA
- 64 SPECTRA
- 66 HORIZONTAL
- 68 NAVY
- 70 ENIF
- 72 GEMINI
- 75 FRANCESCA LUX
- 77 CLAUDIA LUX
- 78 ALESIA
- 81 VEGA
- 83 BELLATRIX
- 84 ATLAS
- 86 CORONA
- 88 MIRACH
- 90 PARIS
- 92 VIENNA
- 94 NOBILIA
- 97 ARGENTINA
- 99 SIRIUS
- 101 VELORUM
- 103 CORIUM SLIDE
- 105 WALL
- 107 TWINS

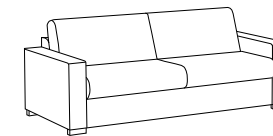

- 109 AMIRA
- 111 SIESTA
- 113 SOFABED BARI
- 115 SOFABED TORVI
- 117 SOFABED SINGLE
- 119 SOFABED DOUBLE

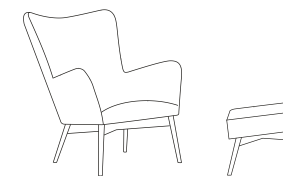

- 120 BOUDOIR MONT BLANC
- 121 MONT BLANC
- 122 BOSS
- 123 MOON
- 124 PUFF
- 126 BOUDOIR BREEZE
- 127 BREEZE
- 128 DE LUXE
- 129 MODERN
- 130 CUT
- 130 CASTELO
- 130 CROSS

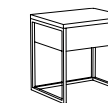

- 131 DAMIANI SWISS
- 131 VITO
- 131 PIETRO
- 132 NIMO
- 132 VITORIO U
- 132 VITORIO L
- 133 ANA
- 133 ANITA
- 134 INDUSTRY
- 134 HEAVY OAK
- 134 OAK
- 135 DAMIANI
- 135 CUBE
- 135 LA SPEZIA

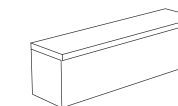

- 136 TABURET BENCH

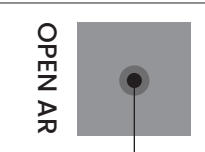

Chcete si predstaviť, ako bude posteľ vyzerať priamo vo vašej izbe?

VYUŽITE FUNKCIU OPEN AR PRI VYBRANÝCH MODELOCH!

Stačí naskenovať QR-kód mobilom alebo tabletom a posteľ si môžete pozrieť priamo u vás doma – zladíte si ju so štýlom vášho bývania, prezrite si ju zo všetkých uhlov a uistíte sa, že sa vám dokonale hodí.

m

Spoločnosť Materasso s. r. o. je rodinná firma, ktorá je na trhu už viac ako 30 rokov.

Na českom a európskom trhu, a v posledných rokoch aj na mimoeurópskych trhoch, je známa výrobou certifikovaných zdravotných matracov, dizajnových postelí, interiérových doplnkov (taburety, kreslá, nočné stolíky...) a posteľových doplnkov (prikrývky, vankúše, matracové chrániče).

Vďaka neustále sa rozrastajúcemu sortimentu našich výrobkov, použitiu kvalitných materiálov, dodržiavaniu certifikovaných výrobných postupov a následnému servisu rozširujeme rady spokojných zákazníkov – a to bežných klientov i profesionálov (interiérových dizajnérov alebo hoteliérov).

Spálňa je najintímnejším a najdôležitejším miestom vo vašej domácnosti.

Je to miesto odpočinku a relaxácie tela i všetkých zmyslov po celodennej námahe. Tam získavate silu a pripravujete sa na nové výzvy.

Uvedomujeme si, že ústredným bodom spálne je posteľ, ktorá jej dáva dušu aj charakter. Preto kolekciu našich postelí charakterizuje nielen pevná konštrukcia a perfektné vypracovanie, ale zároveň aj krásny dizajn, bohatý výber poťahových látok a ich farebného prevedenia.

V spojení s ponukou našich zdravotných matracov vám poskytneme komfort a pohodlie tej najvyššej úrovne. Veľký dôraz kladieme na funkčnosť a možnosť vytvorenia modelov postelí presne podľa vašich predstáv.

Vďaka veľkému množstvu variácií v ponuke tvarov a dizajnov, tiež farieb a doplnkových funkcií, určite nájdete v našej ponuke posteľ, ktorou dotvoríte štýl vášho interiéru tak, aby sa spálňa stala najútulnejším miestom vo vašom dome.

Stavíme na silnom tíme kvalifikovaných odborníkov s dlhoročnými skúsenosťami v oblasti výroby ortopedických matracov a postelí a zároveň na kvalite našich výrobkov.

Ponúkame možnosť kombinácie rôznych spacích systémov s bohatým výberom moderných čiel postelí v rôznych dizajnoch a spôsoboch spracovania.

Vyrábame rôzne typy korpusov postelí s užšími alebo silnejšími bočnicami, posteľe v štandardnej aj atypickej dĺžke, v pohodlných boxspringových verziách, známych predovšetkým z hotelov.

Zákazník si môže zvoliť verziu bez alebo s úložným priestorom. Individuálny je aj výber roštov od klasických pevných, s výklopom alebo s elektrickým pohonom polohovania.

Neustále sledujeme nové technológie a trendy v interiérovom dizajne. Ich následná aplikácia do výroby nám umožnila vytvoriť ucelenú a dizajnovú úspešnú kolekciu postelí i celých spálňových setov.

Dizajn a štýl postelí je umocnený použitím kvalitných čalúnických poťahových látok. V našej ponuke nájdete nielen látky s originálnymi vzormi a štruktúrami, ale tiež látky so špeciálnou úpravou pre ľahké čistenie, látky odolávajúce absorpcii tekutín a nečistôt.

Každú posteľ z ponuky (v akomkoľvek prevedení korpusu) je možné doladiť vhodným výberom nožičiek v rozmanitých prevedeniach – či už ide o materiál, tvar alebo výšku.



Možnosti uloženia matracu:

1. SYSTÉM SO ZAPUSTENÍM MATRACA:

Matrac je zapustený do rámu postele, čo znamená, že vonkajší rozmer postele je väčší než rozmer matracu.

Tento spôsob je možný iba pri rámových posteliach.



2. SYSTÉM CORIUM:

Matrac je položený na spací systém (rámová posteľ alebo boxspring), pričom vonkajšie rozmery matracu sú totožné s rozmermi spacieho systému postele.

POSTELOVÉ SYSTÉMY

Každý posteľový systém je možné kombinovať s ľubovoľným čelom postele a nožičkami. Môžete si vybrať z veľkej ponuky kvalitných čalúnnických látok.

Ku každej posteli je možné objednať aj taburet, kreslo alebo podnožku ku kreslu v rovnakej látke.

Výšky spacích systémov sú uvedené bez nožičiek. Všetky postele v rámci detského a teenager programu vyrábame už od šírky 90 cm.

Celý korpus postele (bez čela a roštov) je balený v kartónovej krabici, čo zjednodušuje prepravu a zlepšuje ochranu pri manipulácii.

Vo všetkých montovaných spojoch pri rámových korpusoch sú použité matice a skrutky s metrickým závitom, umožňujúce aj opätovnú bezproblémovú montáž.

POUŽITÉ SKRATKY

UP – úložný priestor
BV – bočný výklop
NV – nožný výklop

NEW



BOXSPRING SLIDE

Boxspring je navrhnutý s ohľadom na maximálny komfort a funkčnosť. Vďaka kombinácii taštičkovej pružiny a vrstvy PUR 35 vo vrchnej časti boxspringu poskytuje optimálne pohodlie na spanie. Táto kombinácia zaisťuje dostatočnú oporu tela a súčasne pružnosť, ktorá prispieva k relaxačnému a zdravému spánku.

Tento boxspring je ideálnou voľbou pre tých, ktorí ocenia praktickosť zakomponovanej extra prístelky bez kompromisov v pohodlí. Lineárne výsuvné kovania umožňujú jednoduchú a plynulú manipuláciu. Matrac prístelky si môžete vybrať podľa vlastných preferencií, pričom maximálna výška matracu je 20 cm.

NEW



HIGHLIGHT

Box je čalúnený v rovnakej látke ako čelo postele a na ložnej ploche boxspringu je špeciálna poťahová látka s úpravou ANTISLIP, ktorá dokonale fixuje matrac proti posunu. Výška bočnice boxu je 10 cm.



BOXSPRING 22-32 CM

Je najpokročivejší postel'ový systém. Jeho obľúbenosť je daná špecifickou konštrukciou: masívny rám boxspringu obklopuje pružinovú kostru, ktorá zaisťuje bodovo prispôsobivý podklad pod matracom, zlepšuje kopírovacie vlastnosti a celkovú prispôsobivosť použitého matracu. Také zloženie vytvára výnimočný systém dvojitého kopírovania prirodzeného tvaru tela.

Boxspring je čalúnený v rovnakej látke ako čelo postele a na ložnej ploche boxspringu je špeciálna poťahová látka s úpravou ANTISLIP-dokonale fixujúci matrac proti posunu. Výška bočnice boxspringu je 22 alebo 32 cm. Matrac nie je zapustený do rámu postele, ale lícuje s boxspringom.



BOX UP VÝKLOP MAXI

UP MAXI 40, UP MAXI 100 a tiež UP MAXI ELECTRIC je ideálnym riešením pre všetkých, ktorí hľadajú komfortnú posteľ, ktorá je doplnená o veľký úložný priestor vo vnútri postele. Konštrukcia znižuje požiadavky na priestor v spálni a dovoľuje použiť aj rozmerovo väčší matrac oproti tradičnému typu postele.

Úložný priestor bez vnútorných deliacich priečok poskytuje výnimočne veľký priestor s výborným prístupom po celej ploche. Box UP MAXI 40 bude bez problémov zdvíhať matrac do celkovej hmotnosti 40 kg. Pre matrace s vyššou hmotnosťou je určený systém UP MAXI 100. Ten disponuje so 4 ks kovania a piestov pre ľahké zdvíhanie veka úložného priestoru spolu s ťažkými matracmi. Zdvíhanie veka u UP MAXI ELECTRIC zaisťuje elektrický mechanizmus. Výška boxu je 32 cm.



UP WOOD

Je určený pre tých, ktorí potrebujú viac úložného priestoru v spálni a tiež uprednostňujú jeden spoločný partnerský matrac. Rám postele má hrúbku 3, 5 alebo 8 cm, a výšku 30 alebo 35 cm.

Vybavený je konštrukciou a roštom z masívneho bukoveho dreva. Konštrukcia sa z prednej časti postele vyklápa pomocou kovania s pneumatickými piestami, ktoré uľahčujú prístup do úložného priestoru aj pri použití ťažkých matracov.



UP METAL

Je určený pre tých, ktorí potrebujú viac úložného priestoru v spálni a tiež uprednostňujú jeden spoločný partnerský matrac. Rám postele má 3, 5 alebo 8 cm hrúbku, 30 alebo 35 cm výšku.

Vybavený je špeciálnym roštom s kovovou konštrukciou, ktorý sa z prednej časti postele vyklápa pomocou kovania s pneumatickými piestami, ktoré uľahčujú prístup do úložného priestoru aj pri použití ťažkých matracov. Kovový rám roštu je osadený predpätými lamelami. Demontážou dna v úložnom priestore získame prístup pod celou plochou postele, čo oceníte predovšetkým pri upratovaní.



UP METAL LIFT-UP

Vylepšením UP metal je METAL LIFT-UP, uľahčujúci prístup do úložného priestoru v oblasti čela postele a tiež veľmi zjednodušuje výmenu posteľnej bielizne.

METAL LIFT UP musí byť na posteli s ťažšími matracami, inak sa s ním zle manipuluje.



UP BV | UP NV

Dizajnová posteľ UP BV a UP NV (s polohovaním hlavy) je s použitím drevených výklopných roštov. Pre túto posteľ je vhodné použiť dva samostatné matrace, aby bolo možné plnohodnotne využívať výklopné rošty.

Matrac pri použití roštov METAL, DOBLE NV a DOUBLE BV je zapustená 6 cm od vrchnej hrany bočnice.

V prevedení Corium je možné rošt namontovať vo výške bočnej hrany bočnice a matrac je uložený aj na rošte, aj na bočniciach. Takáto posteľ bude pôsobiť dojmom boxspringu a šírka postele (vrátane bočníc) bude rovnaká so šírkou matraca.



BEZ ÚLOŽNÉHO PRIESTORU

Dizajnová posteľ je určená pre tých, ktorí nepotrebujú úložný priestor v posteli. Rám postele je podobný ako pri posteli s UP, neobsahuje však upevnenie pre dno úložného priestoru.

V tomto ráme je možné použiť všetky typy roštov pod matrac: od jednoduchých masivných latových roštov, cez latové masívne v ráme, pružné lamelové, polohovateľné, až po modely s plynulým elektrickým polohovaním. Pre absolútne pohodlie počas spánku, ale aj pre chvíle aktívneho odpočinku, napr. čítanie. Korpusy vyrábame v rôznych hrúbkach bočníc: 3, 5 alebo 8 cm a troch výškach: 15, 30 alebo 35 cm.



BOXSPRING MOBIL

Konštrukcia postele je zhodná s boxspringom 22/32 a je doplnená o funkciu plynulého polohovania hlavy, chrbtovej časti a nôh pomocou elektromotora s ovládačom. Tento typ postelí nemá vystupujúce bočnice a polohovanie umožňuje nastavenie najlepšej pozície pre odpočinok. Iná je poloha na spanie, iná pre aktívny odpočinok (napr. čítanie), iná pri regenerácii boľavých nôh.

Boxspring Mobil ideálne spolupracuje s matracmi zo studených pien, s anatomicky prerezanými jadrami, latexovými matracmi a tiež matracmi z „lenivých“ termoelastických pien.

Tieto matrace presne kopírujú tvar roštu pri polohovaní. Výška boxspringu je 32 cm.

SETY POSTELÍ, ČALÚNENIE STIEN A DOPLNKOV

Novinka, ktorá je veľmi vítaná nielen zo strany interiérových dizajnérov a hotelierov, ale čoraz viac aj zo strany bežných spotrebiteľov, je možnosť objednať si k našim posteliam aj taburet, nočné stolíky, kreslo alebo podnožku ku kreslu v rovnakej čalúnnickej látke ako látka postele.

Pre tých, ktorí už vlastnia kvalitnú posteľ (napríklad z masívu) a plánujú povzniesť interiér svojej spálne, ponúkame možnosť kombinovať v rovnakej čalúnnickej látke jednotlivé interiérové doplnky navzájom, alebo ich zladit' s čalúnením steny za čelom postele. SET (kombinácia) postele a niektorého, alebo všetkých spomínaných interiérových doplnkov v identickej čalúnnickej látke umocňuje celkový dojem z vašej spálne, navodzuje žiadaný pocit elegancie a luxusu a je odrazom vášho jedinečného vkusu a preferencií.





DAMIANI SET

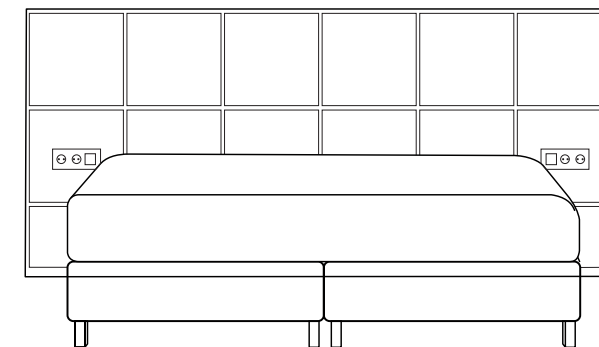

DAMIANI
(p. 45)

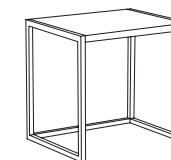
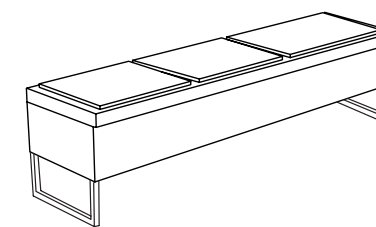

DAMIANI
(p. 135)



CRISTAL SET

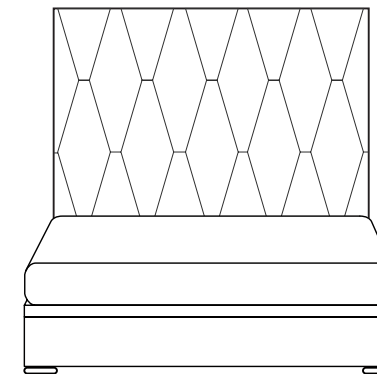

CRISTAL
(p. 41)

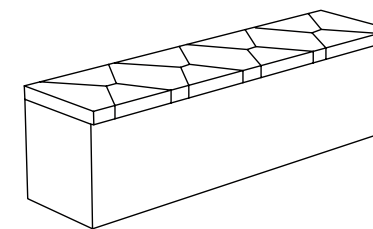

TABURET
No. 5 (p. 137)

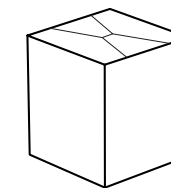

CUBE - CRISTAL
(p. 135)



SPECTRA SET

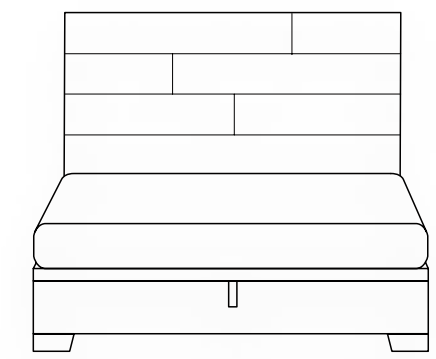

SPECTRA
(p. 64)

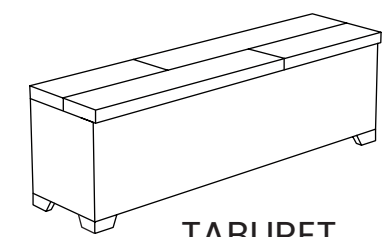

TABURET
No. 7 (p. 137)

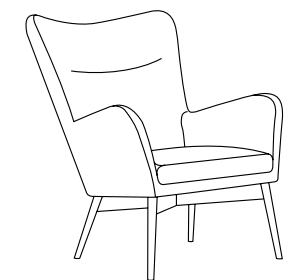

BREEZE
(p. 127)

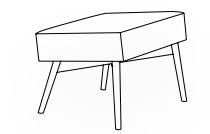

CUT
(p. 130)



CORONA SET

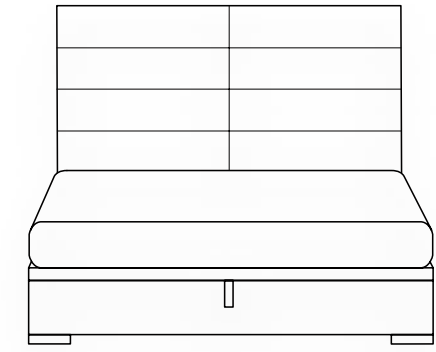

CORONA
(p. 86)

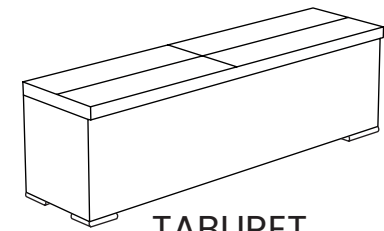

TABURET
No. 4 (p. 137)

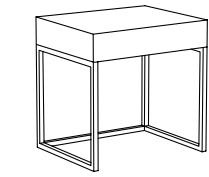

INDUSTRY
(p. 134)

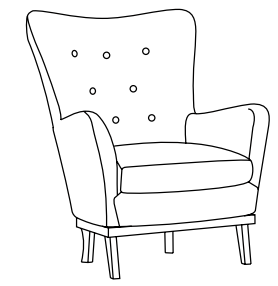

DE LUXE
(p. 128)

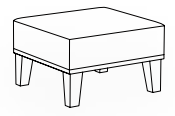

CASTELO
(p. 130)



FRANCESCA LUX SET

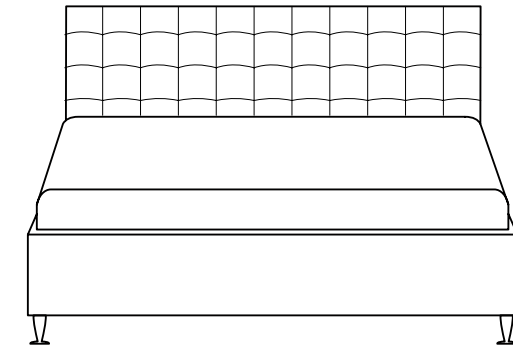

FRANCESCA LUX
(p. 75)

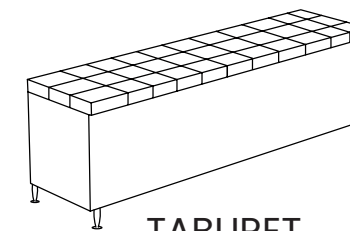

TABURET
No. 12 (p. 137)

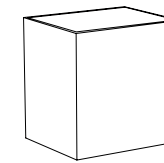

CUBE
(p. 135)

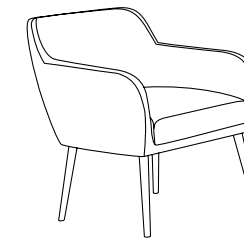

MODERN
(p. 129)



CROSS
(p. 130)



SOUL SET

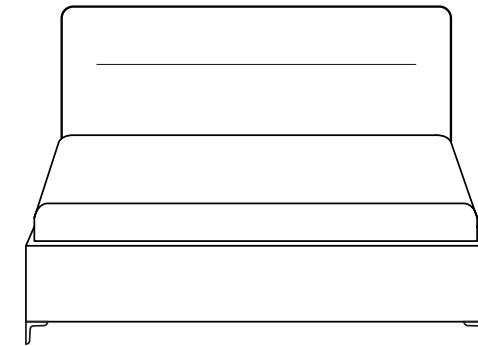

SOUL
(p. 47)

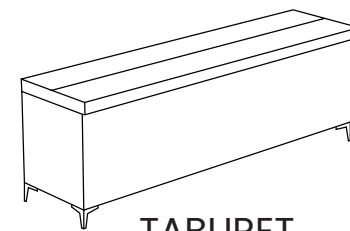

TABURET
No. 1; 3 (p. 137)

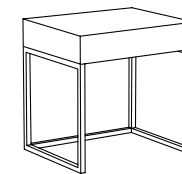

INDUSTRY
(p. 134)

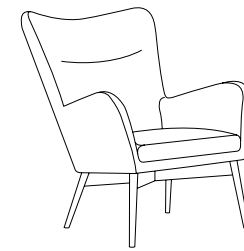

**BREEZE
MIRACH**
(p. 127)



CROSS
(p. 130)

NEW

MONZANO

	L	b ^L	b ^W	b ^H	b ^D	h ^W	h ^H	m ^L	m ^W (cm)
DESING BED	234	210	180	33	10	185	104	200	160

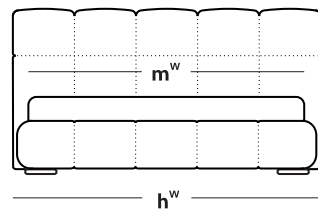
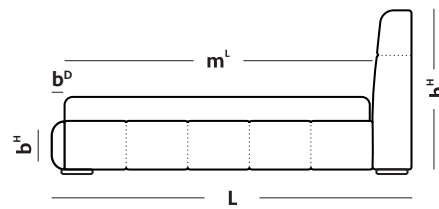
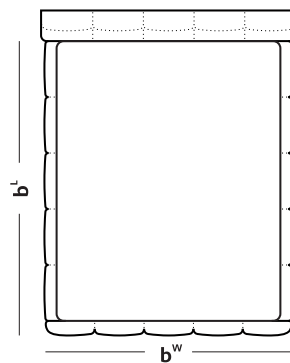

NEW

LINORA

	L	b ^L	b ^W	b ^H	h ^W	h ^H	m ^L	m ^W (cm)
DESING BED	212	205	190	30	190	110	200	180

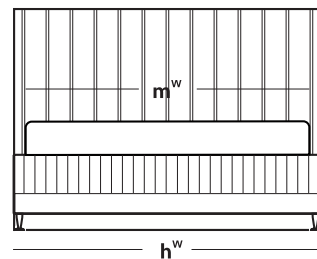
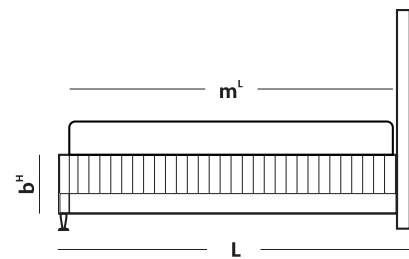
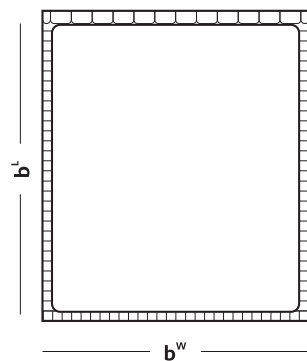

OPEN AR



ENZO

NEW

	L	b ^l	b ^w	b ^h	h ^w	h ^h	m ^l	m ^w (cm)
DESING BED	223	205	190	30	206	113	200	180

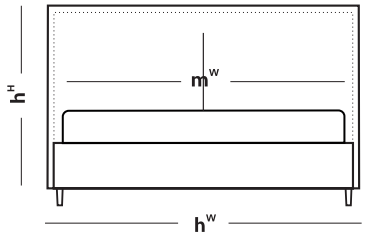
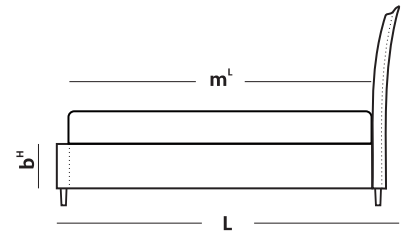
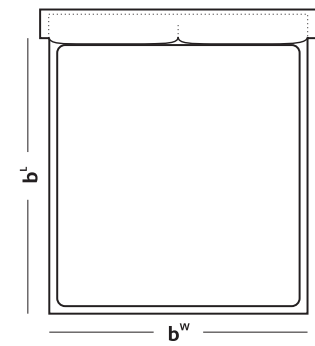



SANDRO

NEW

	L	b ^l	b ^w	b ^h	h ^w	h ^h	m ^l	m ^w (cm)
DESING BED	223	205	190	30	200	110	200	180

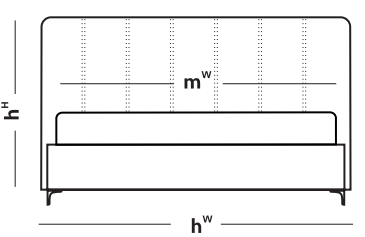
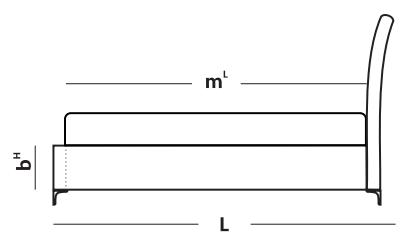
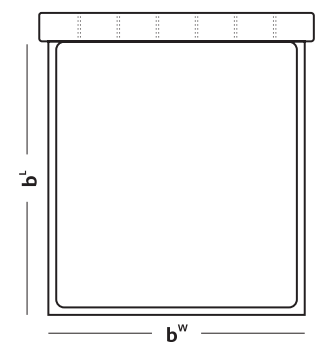



CHESS



	L	b ^l	b ^w	b ^h	h ^w	h ^h	m ^l	m ^w (cm)
DESING BED	211	205	190	30	270	130	200	180

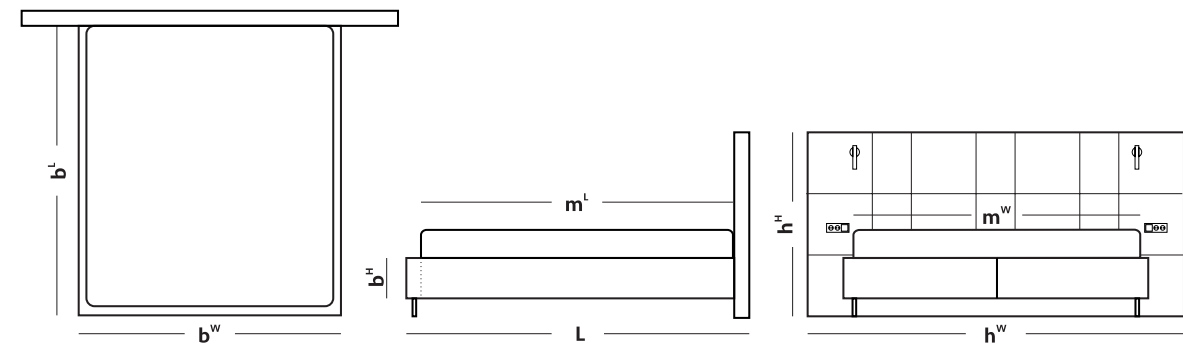



ZINA

NEW

	L	b ^l	b ^w	b ^h	h ^w	h ^h	m ^l	m ^w (cm)
DESING BED	204	200	180	10	316	139	200	180

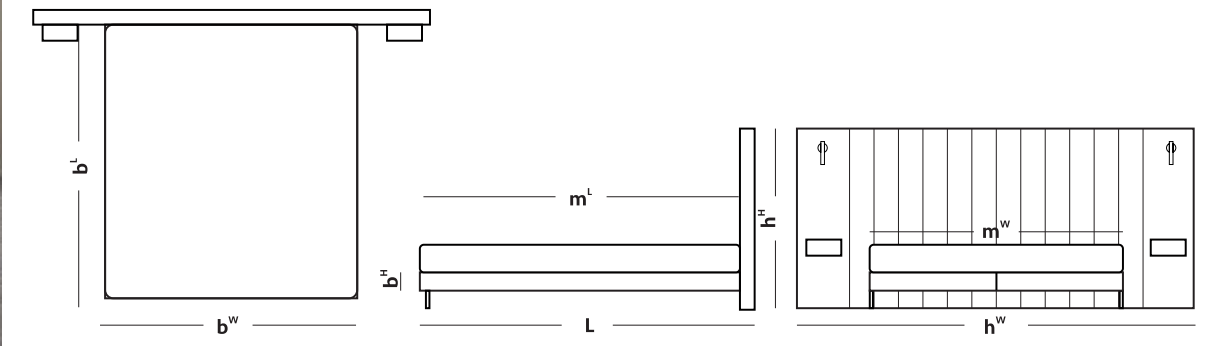



DUNA

NEW

	L	b ^L	b ^W	b ^H	h ^W	h ^H	m ^L	m ^W (cm)
DESING BED	211	205	190	30	190	111	200	180

Taburet
(p. 137)

No. 10

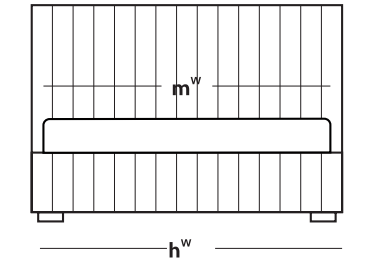
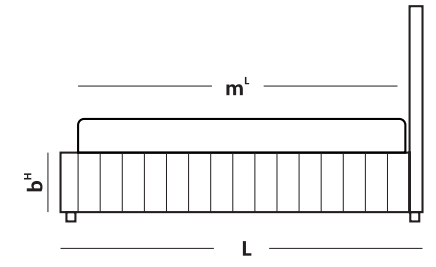
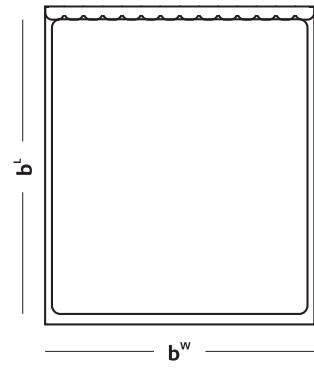
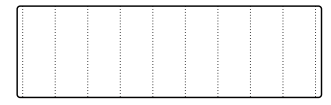



CRISTAL

	L	b ^l	b ^w	b ^h	h ^w	h ^h	m ^l	m ^w (cm)
Maxi Elektro 32	208	200	180	32	180	160	200	180

Taburet
(p. 137)

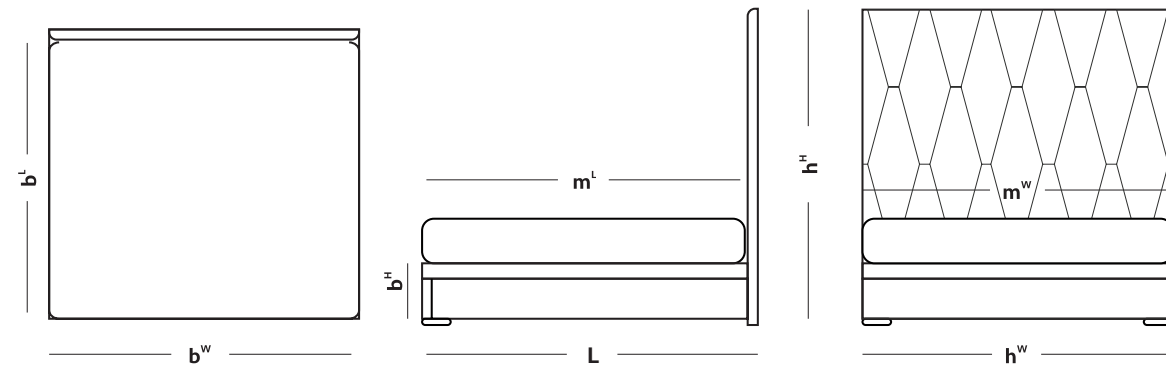
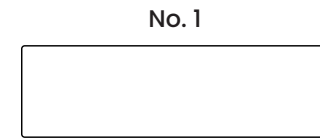
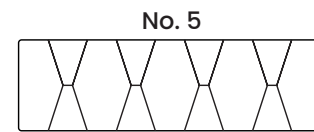



LA SPEZIA

	L	b ^L	b ^W	b ^H	h ^{W1}	h ^{W2}	h ^H	m ^L	m ^W (cm)
DESING BED	213	203	186	35	236	230	130	200	180

Taburet
(p. 137)

No. 1

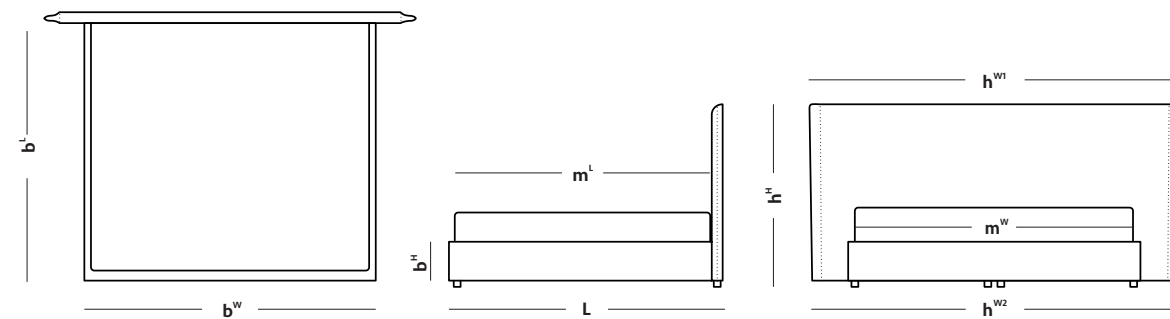

OPEN AR



Width 74.0"

Height 51.0"

17 gal
19 hwy

Front 265/35 ZR 20
Rear 325/30 ZR 21



DAMIANI

	L	b ^L	b ^W	b ^H	h ^W	h ^H	m ^L	m ^W (cm)
BOXSPRING 22	207	200	180	22	272	122	200	180

Taburet
(p. 136)

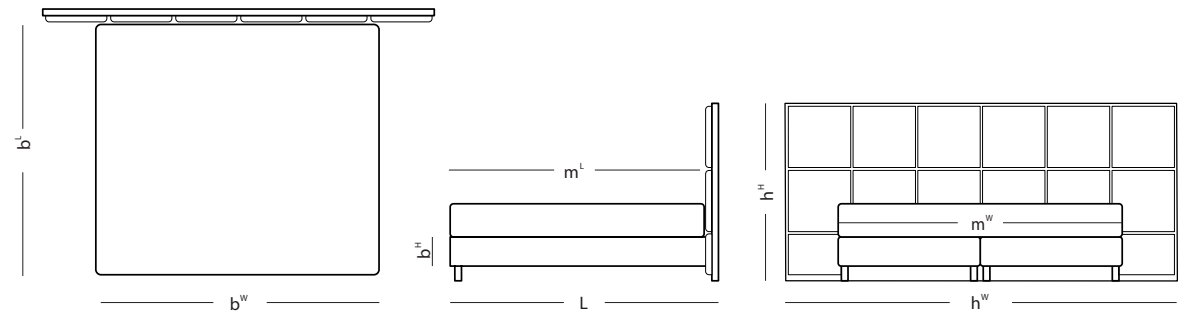
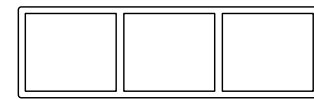



SOUL

	L	b ^L	b ^W	b ^H	b ^D	h ^W	h ^H	m ^L	m ^W (cm)
DESING BED	216	205	190	35	5	196	120	200	180
TYPE CORIUM	211	200	180	35	5	186	120	200	180

Taburet
(p. 137)

No. 1

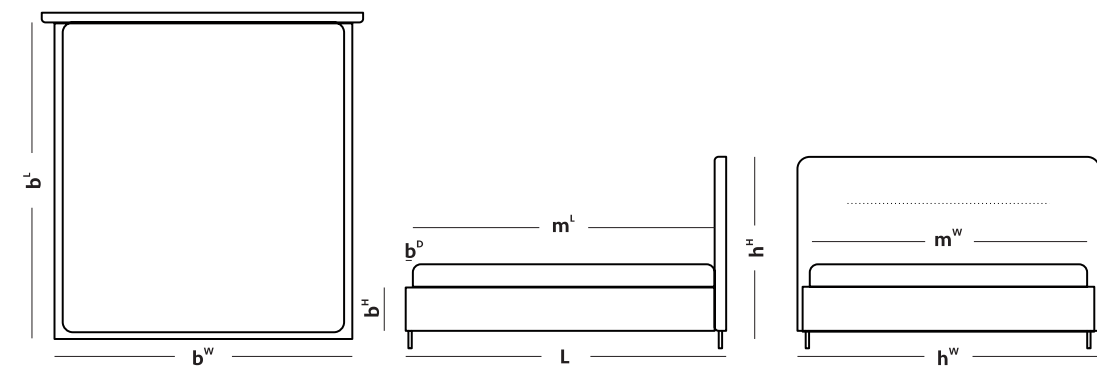



CORIUM

	L	b ^L	b ^W	b ^H	h ^W	h ^H	m ^L	m ^W (cm)
DESING BED	209	200	180	30	180	150	200	180
CORIUM	209	200	160	30	160	150	200	160

Taburet
(p. 137)

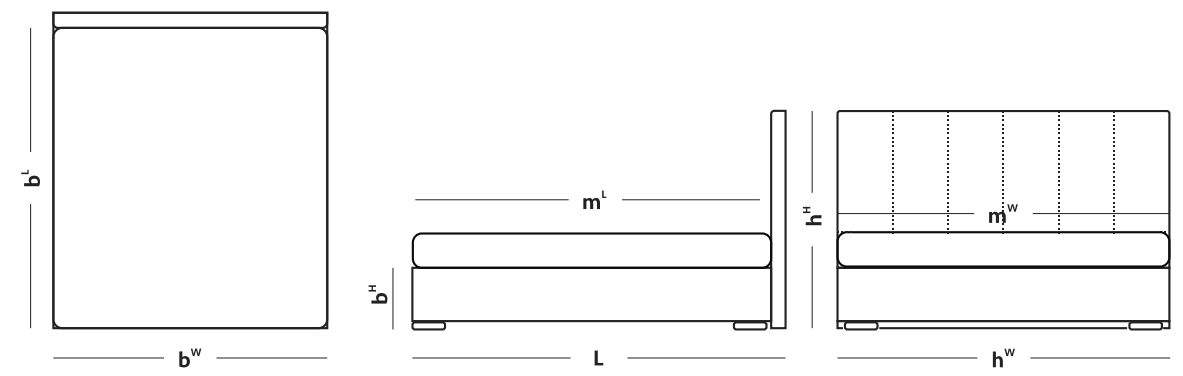
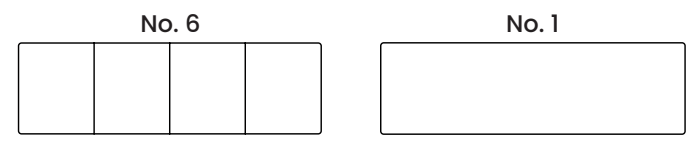



FORREST

	L	b ^l	b ^w	b ^h	h ^w	h ^h	m ^l	m ^w (cm)
BOXSPRING 32	208	200	180	32	180	160	200	180
	208	200	160	32	160	160	200	160

Taburet
(p. 137)

No. 1



No. 18

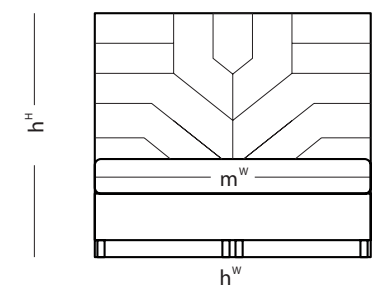
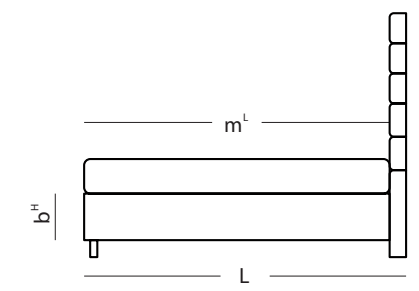
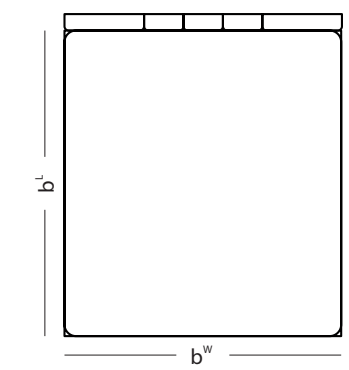
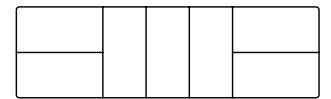



CHESTERFIELD

	L	b ^L	b ^W	b ^H	h ^W	h ^H	m ^L	m ^W (cm)
BOXSPRING 22	213	200	180	22	180	143	200	180
	213	200	160	22	160	143	200	160

Taburet
(p. 137)

No. 1



No.17

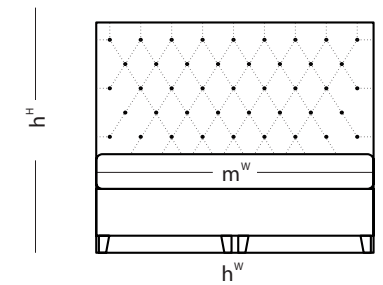
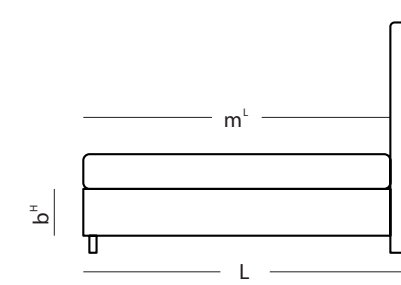
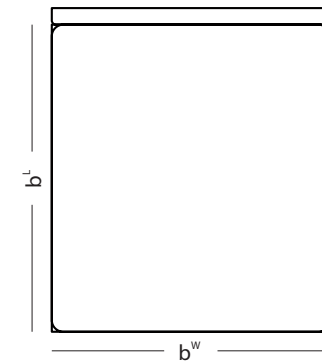
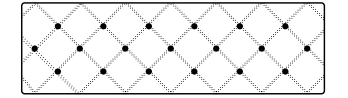



RHOMBUS

	L	b ^L	b ^W	b ^H	h ^W	h ^H	m ^L	m ^W (cm)
BOXSPRING 32	208	200	180	32	180	160	200	180
	208	200	160	32	160	160	200	160

Taburet
(p. 137)

No. 11

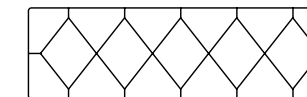

No. 1

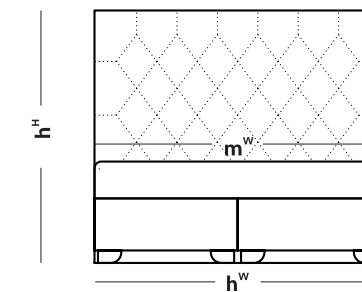
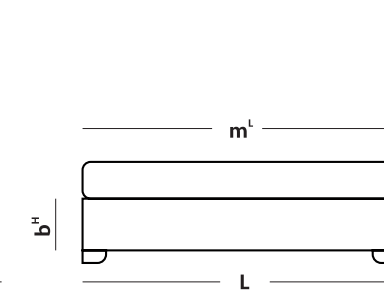
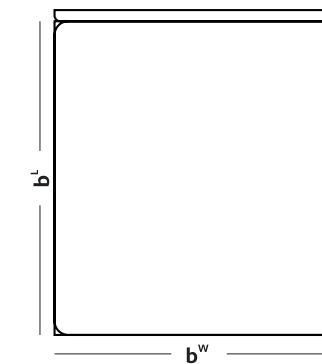



WILD

	L	b ^L	b ^W	b ^H	h ^W	h ^H	m ^L	m ^W (cm)
BOXSPRING 32	208	200	180	32	180	160	200	180
	208	200	160	32	160	160	200	160

Taburet
(p. 137)

No. 16



No. 1

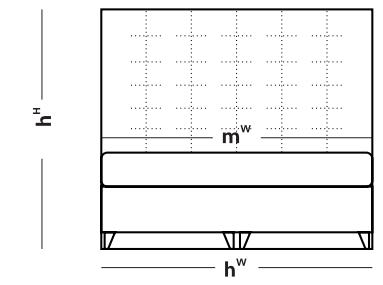
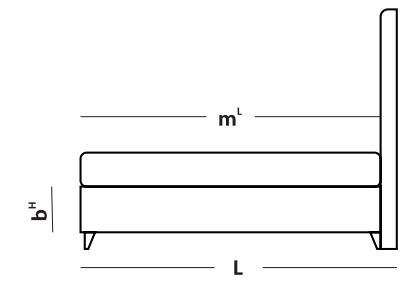
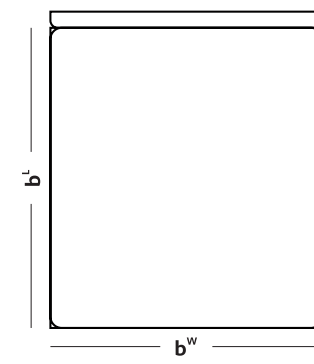



KINGSTONE

	L	b ^L	b ^W	b ^H	b ^D	h ^W	h ^H	m ^L	m ^W (cm)
DESIGN BED	218	205	190	35	5	190	120	200	180
	218	205	170	35	5	170	120	200	160

Taburet
(p. 137)

No. 2

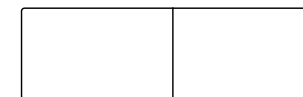

No. 1

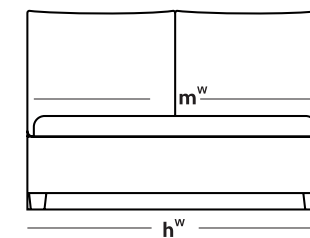
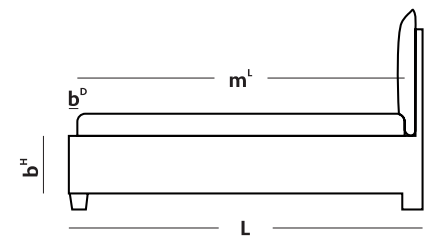
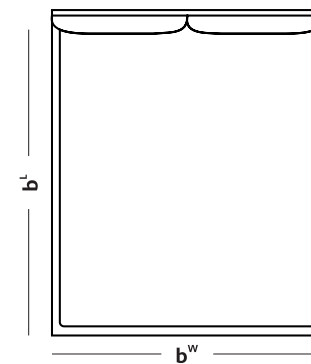



HONEY

	L	b ^L	b ^W	b ^H	b ^D	h ^W	h ^H	m ^L	m ^W (cm)
DESIGN BED	213	205	190	35	5	190	160	200	180
	213	205	170	35	5	170	160	200	160

Taburet
(p. 137)

No. 8

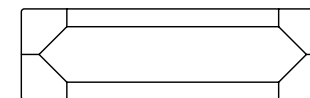

No. 1

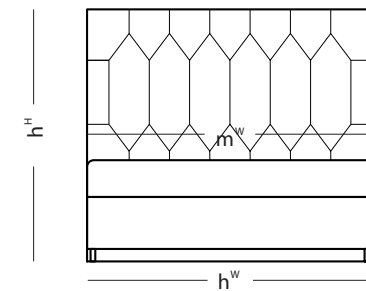
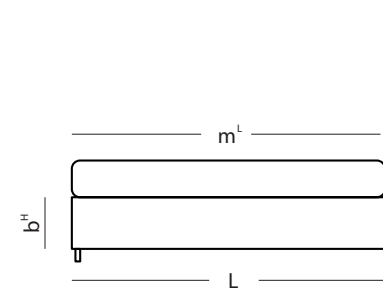
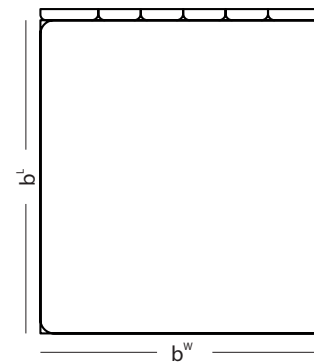

MELVA

	L	b ^l	b ^w	b ^h	h ^w	h ^h	m ^l	m ^w (cm)
BOXSPRING 32	208	200	180	32	186	160	200	180
	208	200	160	32	166	160	200	160

Taburet
(p. 137)

No. 13

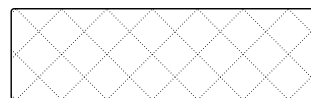

No. 1

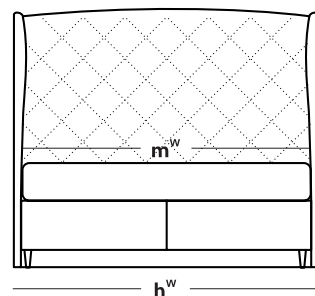
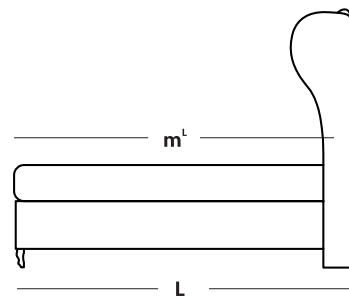
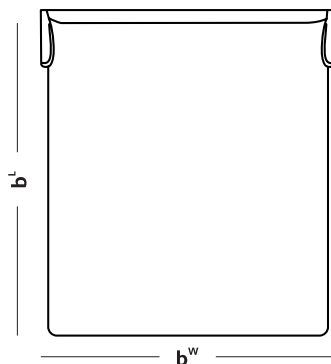

OPEN AR

SPECTRA

	L	b ^l	b ^w	b ^h	h ^w	h ^h	m ^l	m ^w (cm)
MAXI	208	200	180	32	180	130	200	180
	208	200	160	32	160	130	200	160

Taburet
(p. 137)

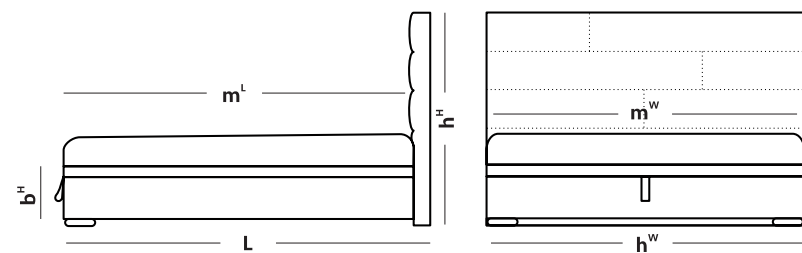
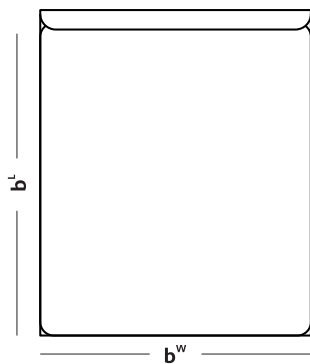
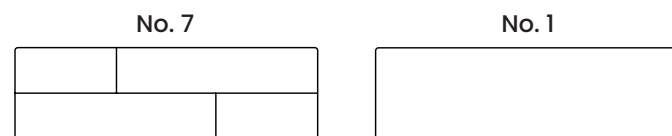

OPEN AR

HORIZONTAL

	L	b ^L	b ^W	b ^H	h ^{W1}	h ^{W2}	h ^H	m ^L	m ^W (cm)
MAXI	210	200	180	32	180	240	145	200	180
	210	200	160	32	160	220	145	200	160

Taburet
(p. 137)

No. 3

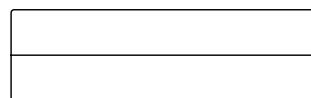

No. 1

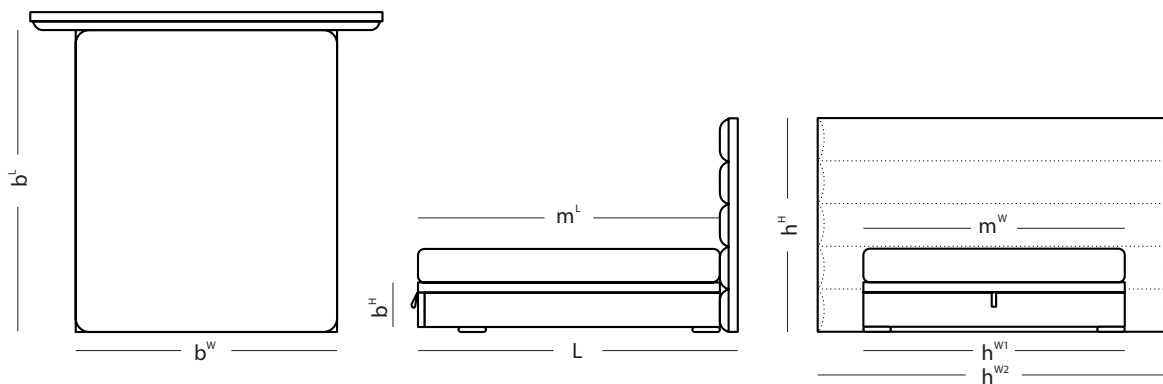

OPEN AR

NAVY

	L	b ^L	b ^W	b ^H	b ^D	h ^W	h ^H	m ^L	m ^W (cm)
DESIGN BED	213	205	190	30	5	190	123	200	180
	213	205	170	30	5	170	123	200	160

Taburet
(p. 137)

No. 1

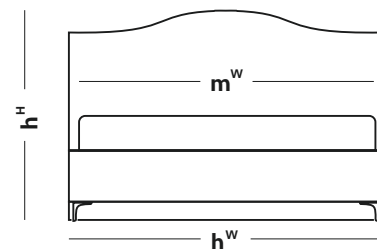
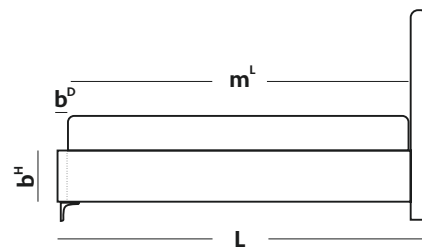
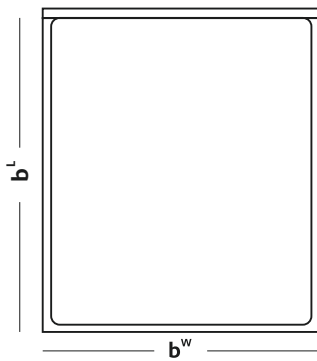

OPEN AR

ENIF

	L	b ^L	b ^W	b ^H	b ^D	h ^W	h ^H	m ^L	m ^W (cm)
DESIGN BED	213	205	190	35	5	196	123	200	180
	213	205	170	35	5	176	123	200	160

Taburet
(p. 137)

No. 1

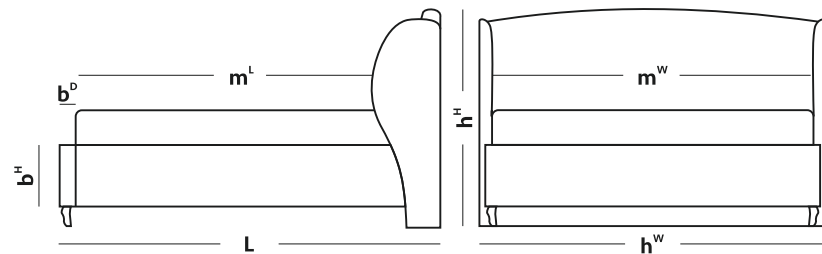
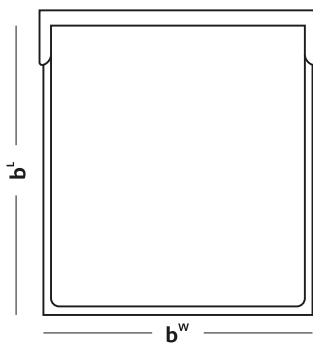

OPEN AR

GEMINI

	L	b ^L	b ^W	b ^H	b ^D	h ^W	h ^H	m ^L	m ^W (cm)
DESIGN BED	213	205	190	30	5	190	150	200	180
	213	205	170	30	5	170	150	200	160

Taburet
(p. 137)

No. 6

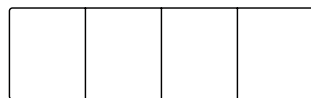

No. 1

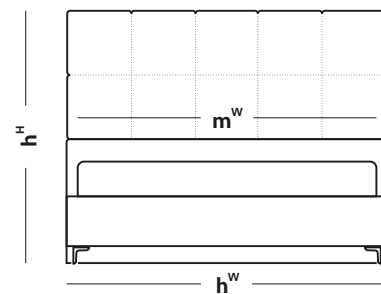
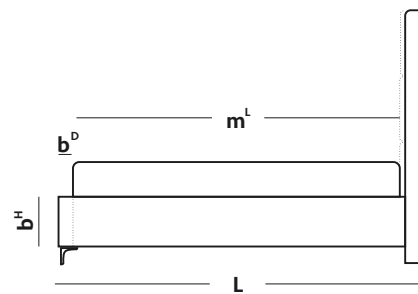
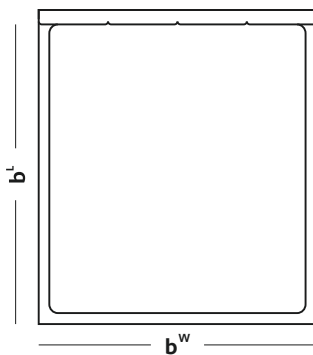

OPEN AR



FRANCESCA LUX

	L1 L2	b ^L	b ^W	b ^H	b ^D	h ^W	h ^H	m ^L	m ^W (cm)
DESIGN BED	231 216	205	190	30	5	190	103	200	180
	231 216	205	170	30	5	170	103	200	160

Taburet
(p. 137)

No. 12

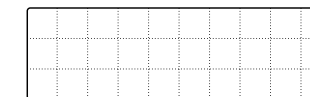

No. 1

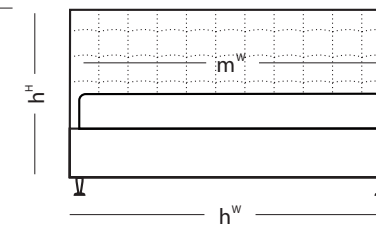
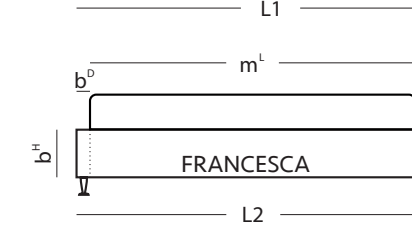
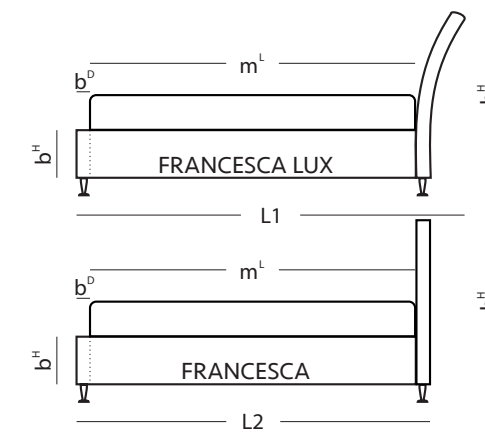
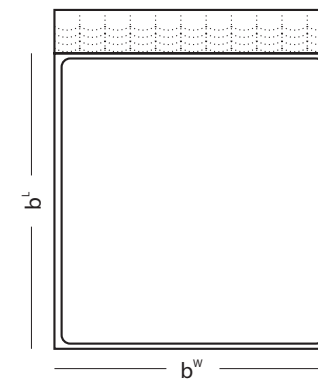



CLAUDIA LUX

	L1 L2	b ^L	b ^W	b ^H	b ^D	h ^W	h ^H	m ^L	m ^W (cm)
DESIGN BED	234 219	208	196	30	8	196	103	200	180
	234 219	208	176	30	8	176	103	200	160

Taburet
(p. 137)

No. 16

No. 1

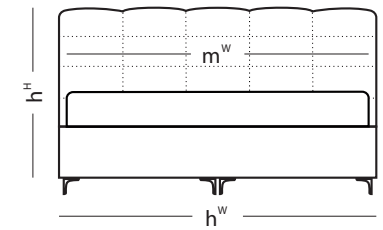
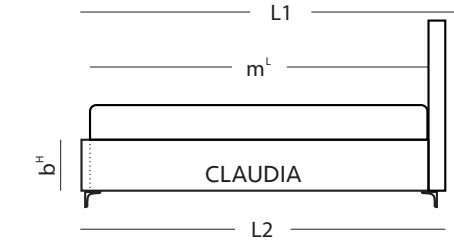
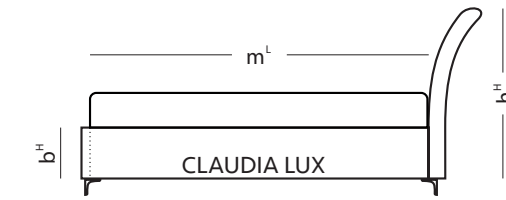
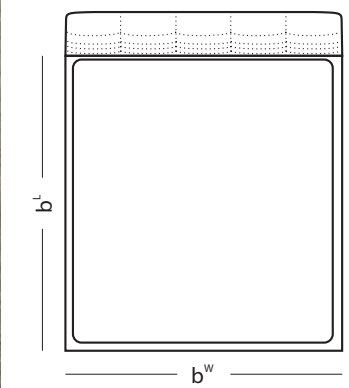

ALESIA

	L	b ^L	b ^W	b ^H	b ^D	h ^W	h ^H	m ^L	m ^W (cm)
DESIGN BED	217	205	190	30	5	190	103	200	180
	217	205	170	30	5	170	103	200	160

Taburet
(p. 137)

No. 13



No. 1

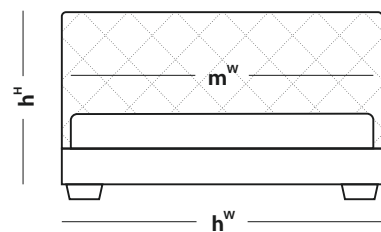
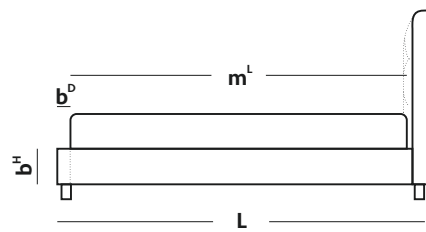
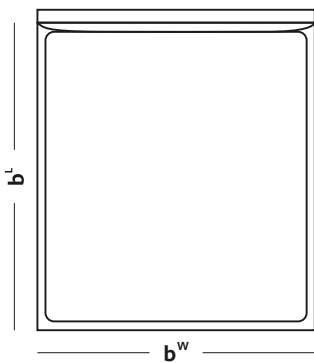

OPEN AR



VEGA

	L	b ^L	b ^W	b ^H	b ^D	h ^W	h ^H	m ^L	m ^W (cm)
DESIGN BED	213	205	190	30	5	190	130	200	180
	213	205	170	30	5	170	130	200	160

Taburet
(p. 137)

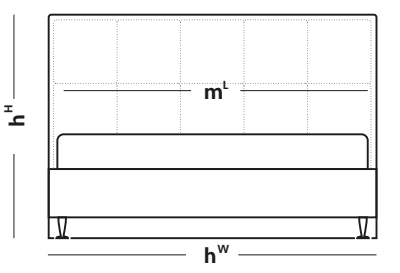
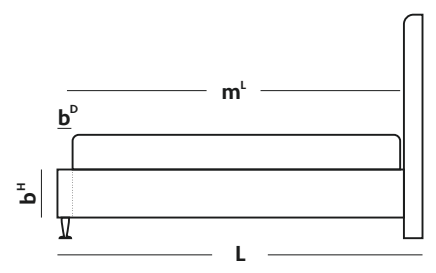
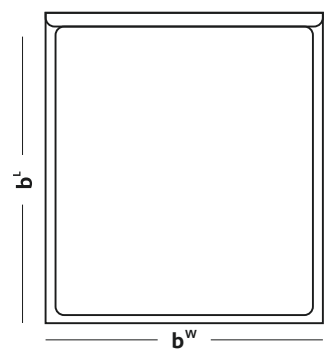
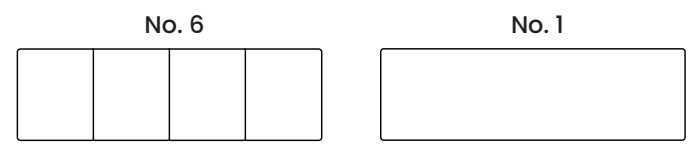



BELLATRIX

	L	b ^L	b ^W	b ^H	b ^D	h ^W	h ^H	m ^L	m ^W (cm)
DESIGN BED	213	205	190	35	5	190	120	200	180
	213	205	170	35	5	170	120	200	160

Taburet
(p. 137)

No. 10

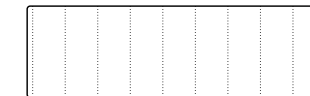

No. 1

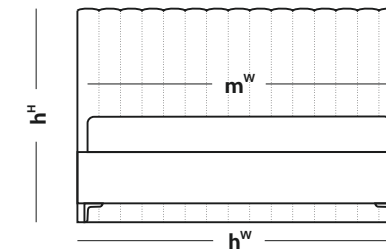
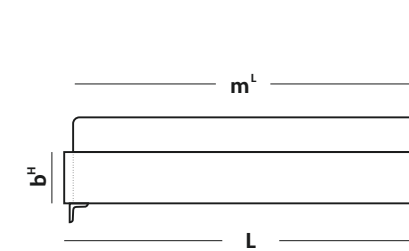
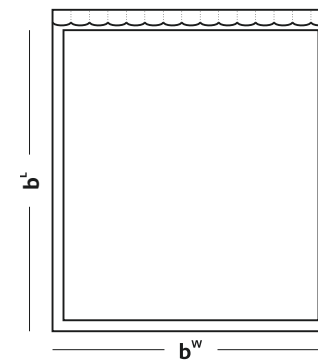

ATLAS

	L	b ^l	b ^w	b ^h	h ^w	h ^h	m ^l	m ^w (cm)
BOXSPRING 22	225	200	180	22	180	100	200	180
	225	200	160	22	160	100	200	160

Taburet
(p. 137)

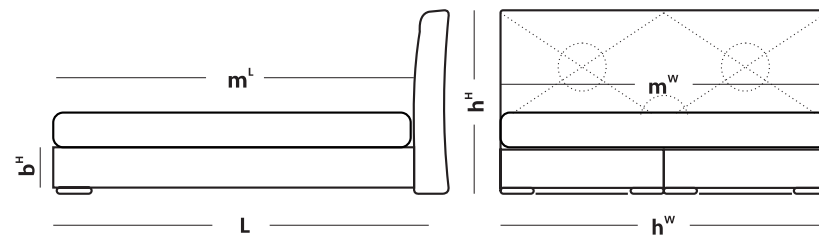
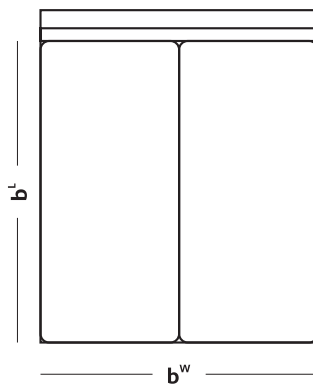
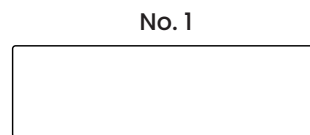
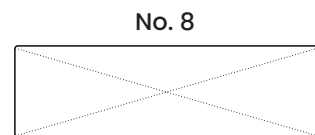

OPEN AR

CORONA

	L	b ^l	b ^w	b ^h	h ^w	h ^h	m ^l	m ^w (cm)
MAXI	208	200	180	32	180	120	200	180
	208	200	160	32	160	120	200	160

Taburet
(p. 137)

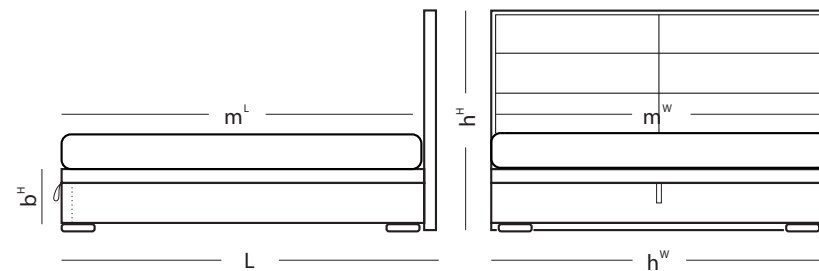
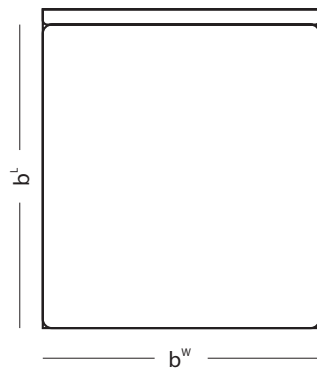
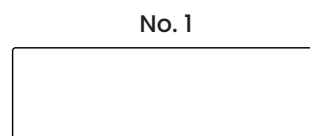
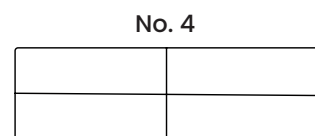

OPEN AR

MIRACH

	L	b ^l	b ^w	b ^h	h ^w	h ^h	m ^l	m ^w (cm)
BOXSPRING 22	208	200	180	22	190	130	200	180
	208	200	160	22	170	130	200	160

Taburet
(p. 137)

No. 5

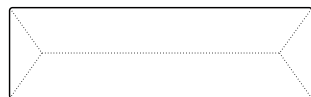

No. 1

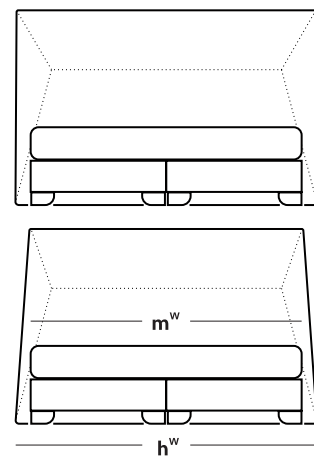
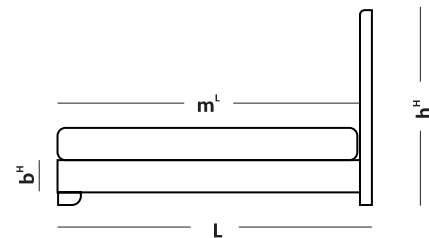
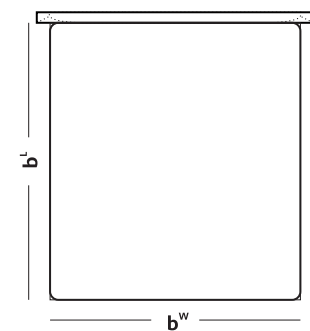

OPEN AR

PARIS

	L	b ^L	b ^W	b ^H	h ^W	h ^H	m ^L	m ^W (cm)
BOXSPRING 32	208	200	180	32	180	197	200	180
+ COVER	208	200	160	32	160	197	200	160

Taburet
(p. 137)

No. 6

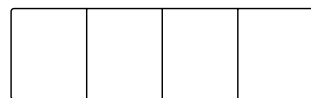

No. 1

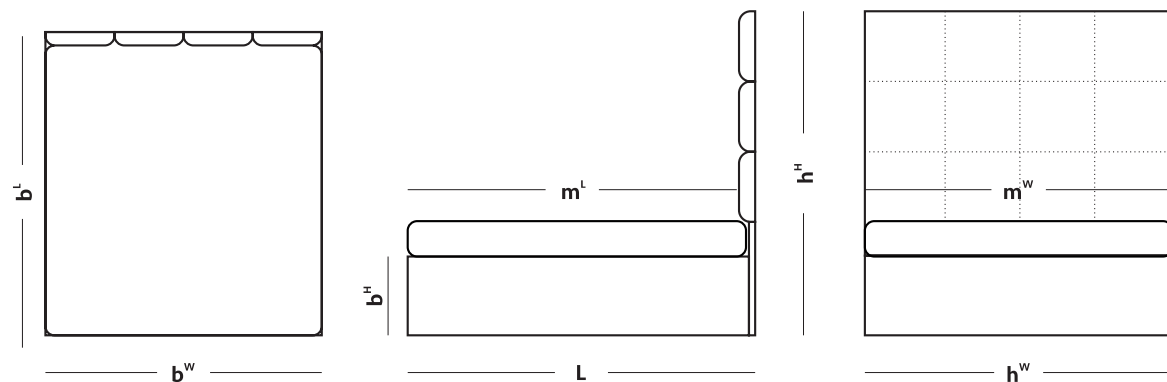

90



OPEN AR

VIENNA

	L	b ^L	b ^W	b ^H	h ^W	h ^H	m ^L	m ^W (cm)
BOXSPRING 32	208	200	180	32	190	160	200	180
	208	200	160	32	170	160	200	160

Taburet
(p. 137)

No. 15

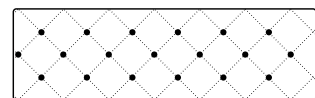

No. 1

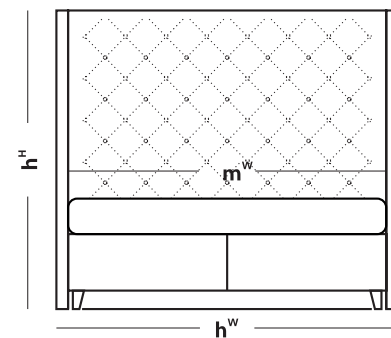
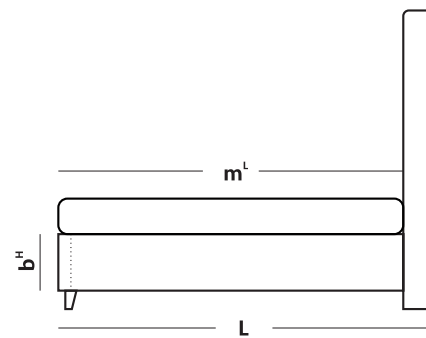
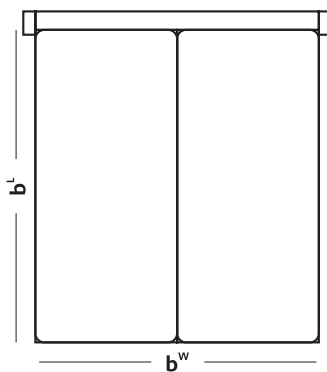

OPEN AR

NOBILIA

	L	b ^L	b ^W	b ^H	b ^D	h ^W	h ^H	m ^L	m ^W (cm)
DESIGN BED	213	205	190	30	5	190	120	200	180
	213	205	170	30	5	170	120	200	160

Taburet
(p. 137)

No. 9



No. 1

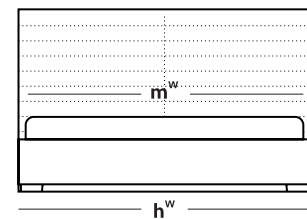
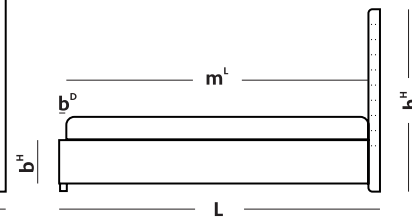
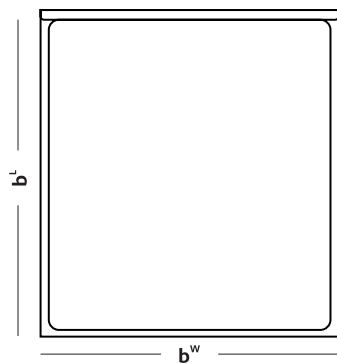



ARGENTINA

	L	b ^L	b ^W	b ^H	b ^D	h ^W	h ^H	m ^L	m ^W (cm)
DESIGN BED	213	205	190	35	5	190	120	200	180
	213	205	170	35	5	170	120	200	160

Taburet
(p. 137)

No. 1

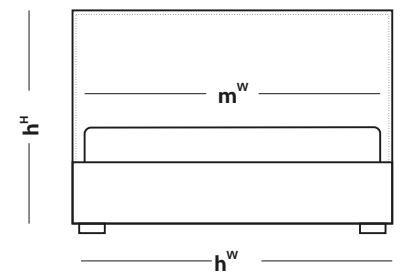
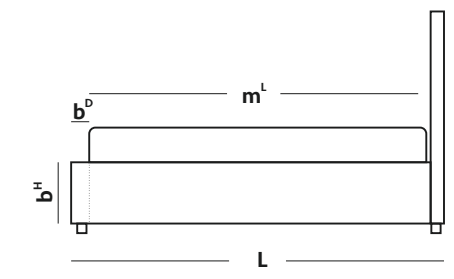
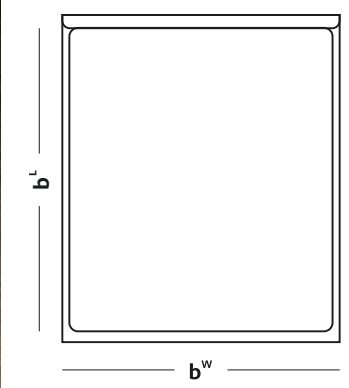



SIRIUS

	L	b ^L	b ^W	b ^H	h ^W	h ^H	m ^L	m ^W (cm)
BOXSPRING MOBIL	208	200	180	32	180	120	200	180
	208	200	160	32	160	120	200	160

Taburet
(p. 137)

No. 1

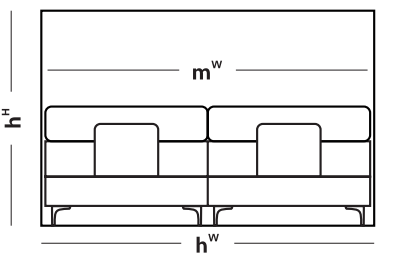
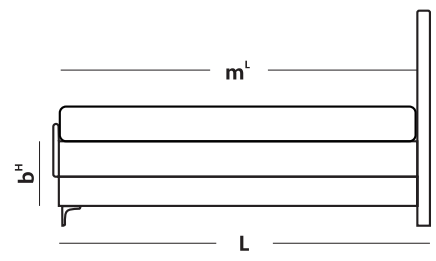
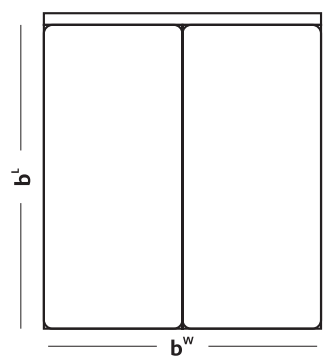
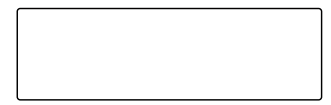



VELORUM

	L	b ^L	b ^W	b ^H	h ^W	h ^H	m ^L	m ^W (cm)
BOXSPRING 32	208	200	180	32	180	120	200	180
	208	200	160	32	160	120	200	160

Taburet
(p. 137)

No. 14

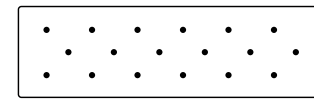

No. 1

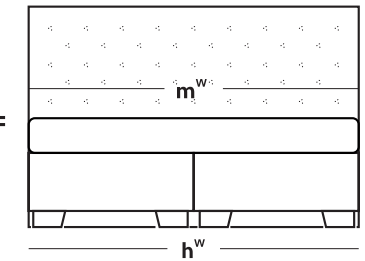
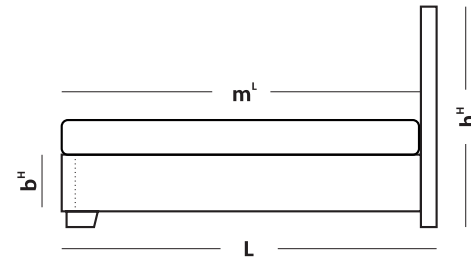
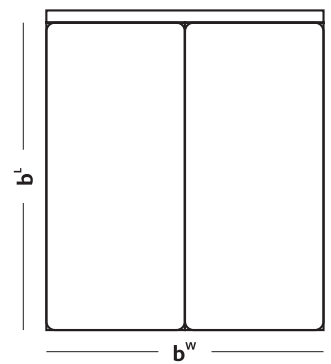



CORIUM SLIDE

NEW

	L	b ^L	b ^W	b ^H	h ^W	h ^H	m ^L	m ^W (cm)
BOXSPRING	210	200	95	46	105	120	200	95
Slide							185	90

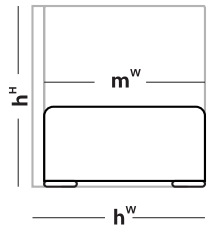
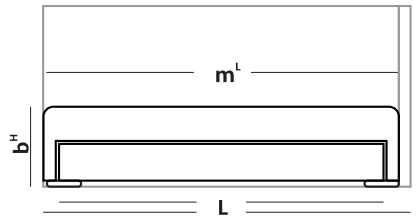
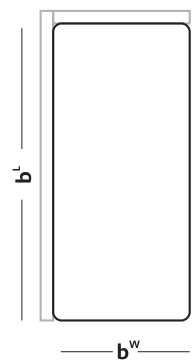



WALL

NEW

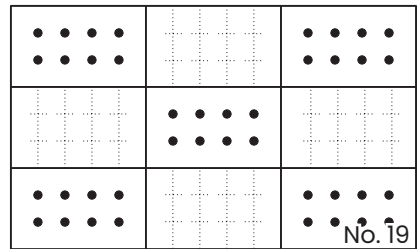
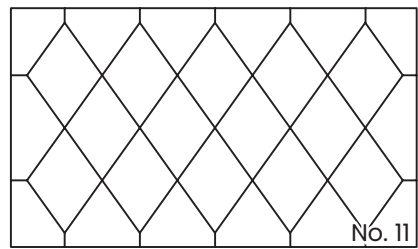
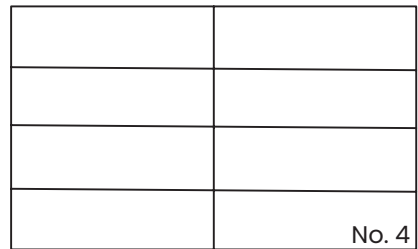
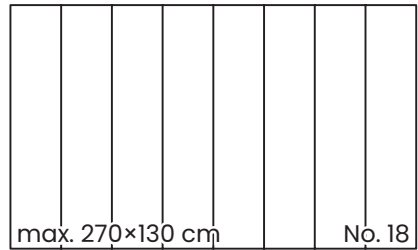
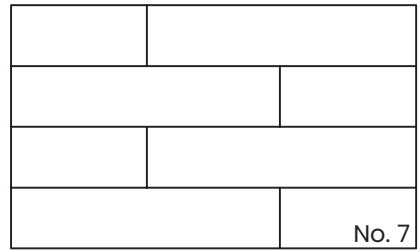
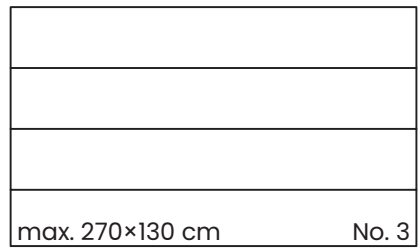
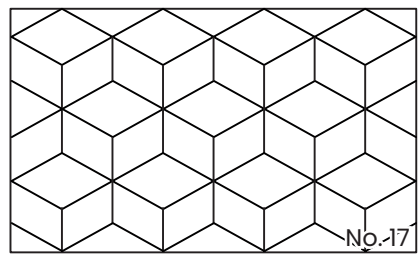
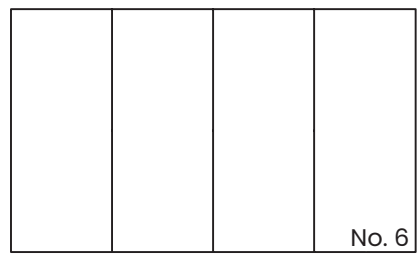
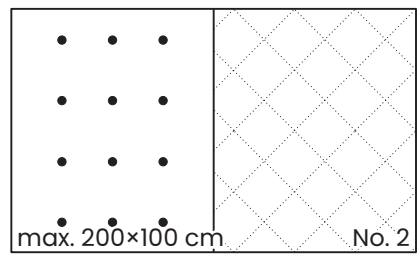



TWINS

L	b ^w	b ^H	b ^{H1}	b ^{H2}	m ^L	m ^w (cm)
224	100	197	30	154	200	90

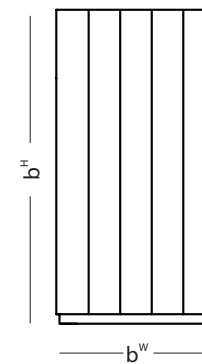
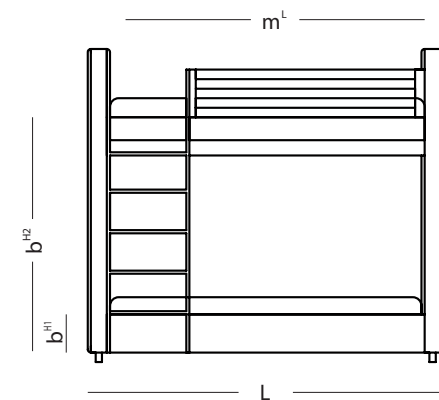
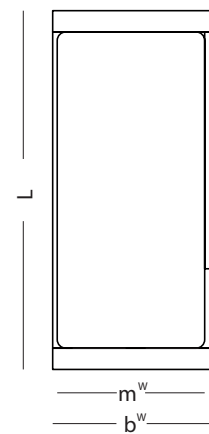

NEW



AMIRA

L	b	h	L ^r	h ^r	L ^w	h ^w (cm)
200	80/90	22 - 45	70	23	80/90	28

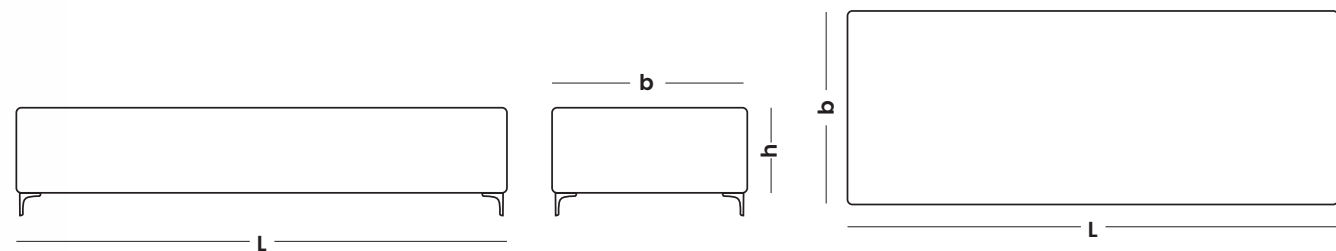
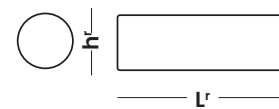

NEW



SIESTA

a	b	c	d	e	f	g	h	L (cm)
80	88	40	75	14	5	60	86	188

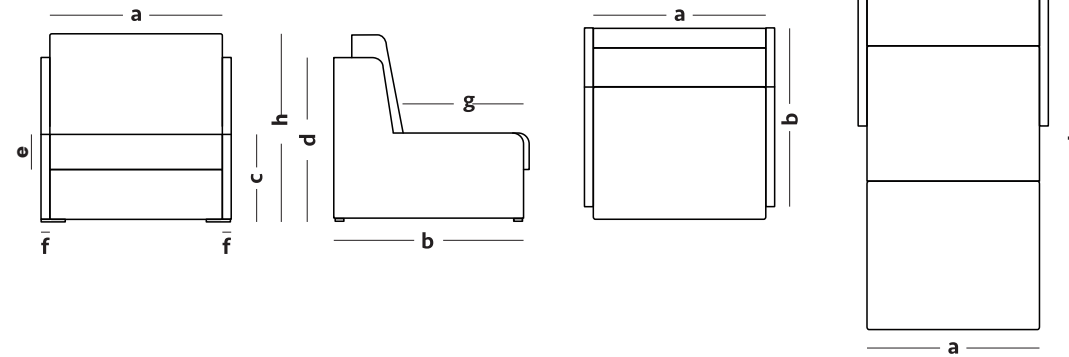

NEW



SOFABED BARI

	a	b	c	d	e	f	g	m ^l	m ^w	L (cm)
BARI DOUBLE	210	49	68	100	62	30	152	190	140	240
BARI TRIPLE	230	49	68	100	62	30	172	190	160	240

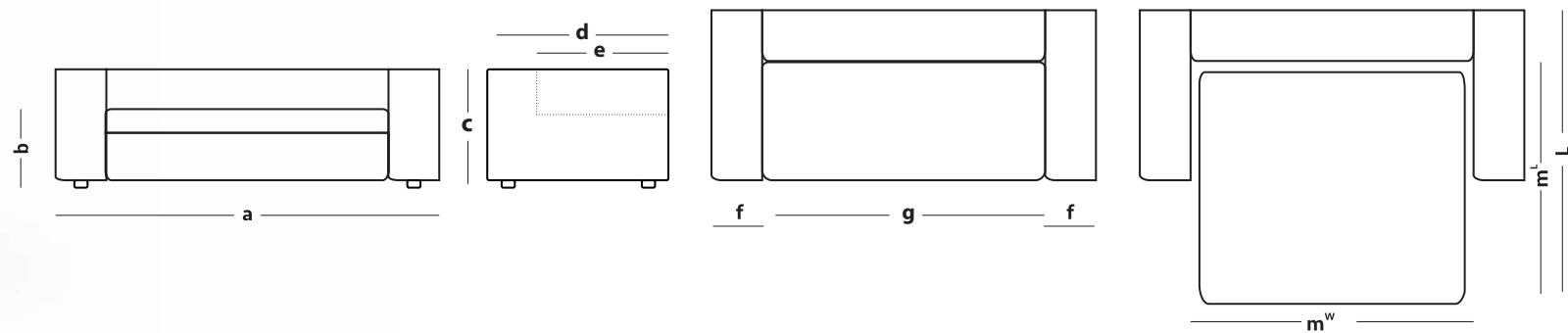

NEW



SOFABED TORVI

	a	b	c	d	e	f	g	h	m ^l	m ^w	L (cm)
SOFABED DOUBLE	163	93	55	56	183	10	60	96	190	140	215
SOFABED TRIPLE	183	93	55	56	203	10	60	96	190	160	215

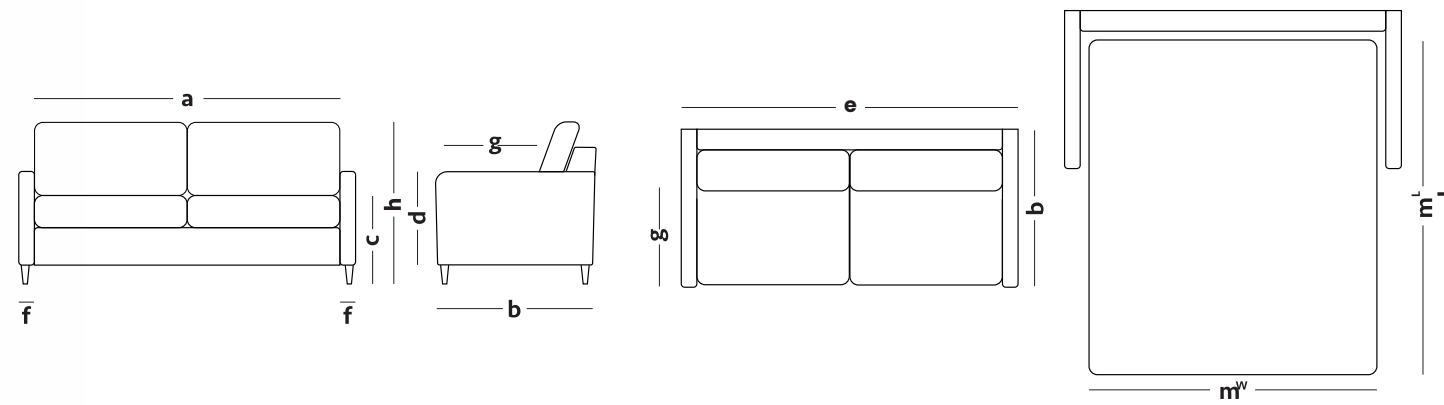



SOFABED SINGLE

a	b	c	d	f	g	h	m ^L	m ^w	L	(cm)
103	98	48	60	13 17 21	55	85	190	80	215	

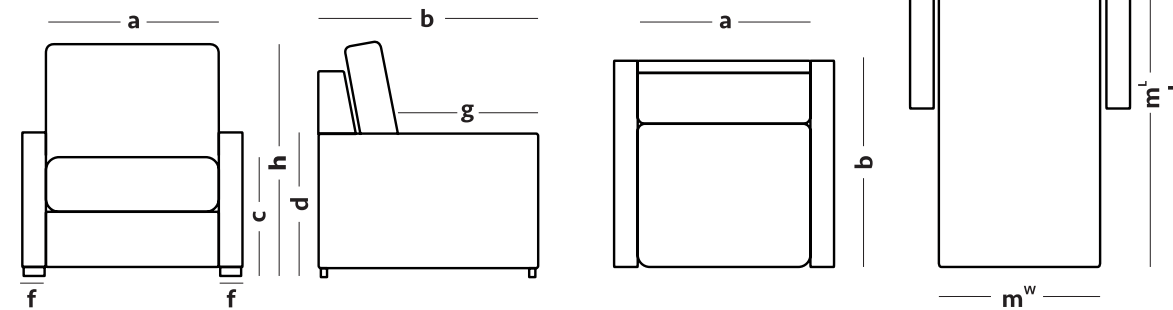



SOFABED DOUBLE

	a	b	c	d	f	g	h	m ^l	m ^w	L (cm)
SOFABED DOUBLE	163	98	48	60	13 17 21	55	85	190	140	215
SOFABED TRIPLE	183	98	48	60	13 17 21	55	85	190	160	215

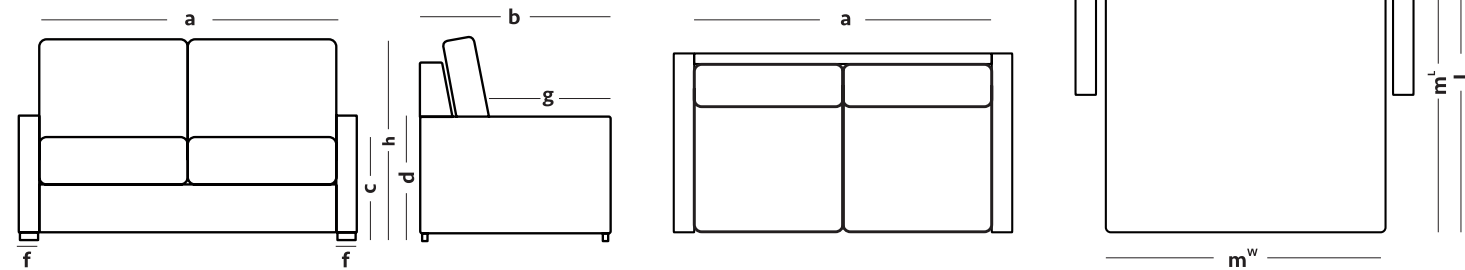

BOUDOIR MONT BLANC

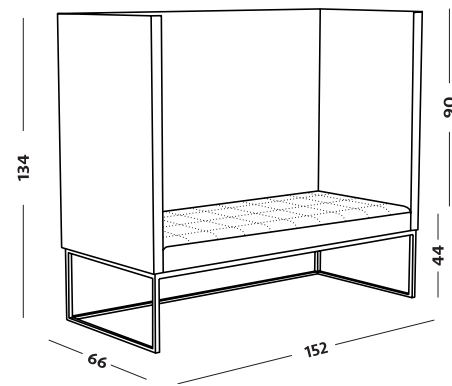

MONT BLANC

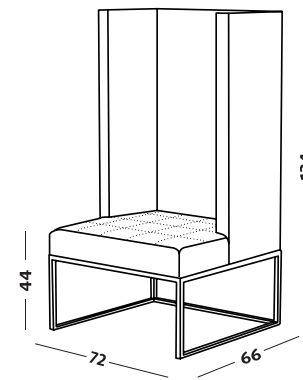



BOSS

a	b	c	d	e	f	g	h	i	(cm)
50	50	105	95	50	50	78	95	30	

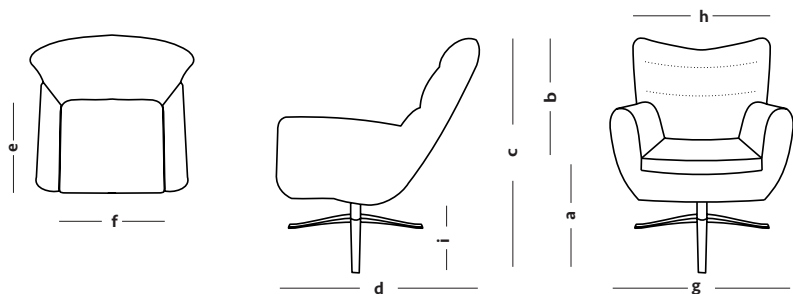

MOON

a	b	c	d	(cm)
93	90	45	63	

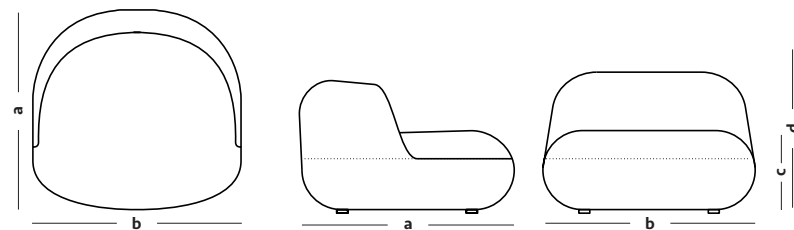

PUFF

NEW

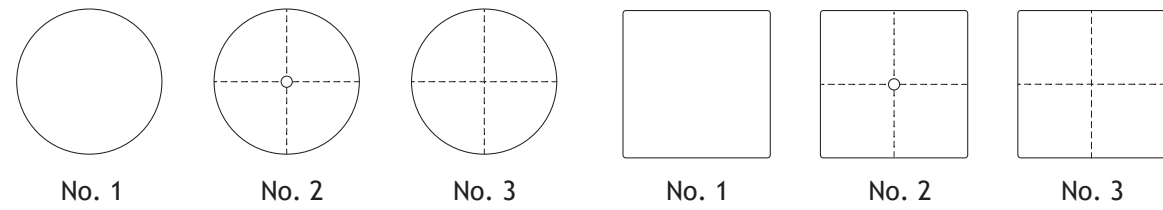
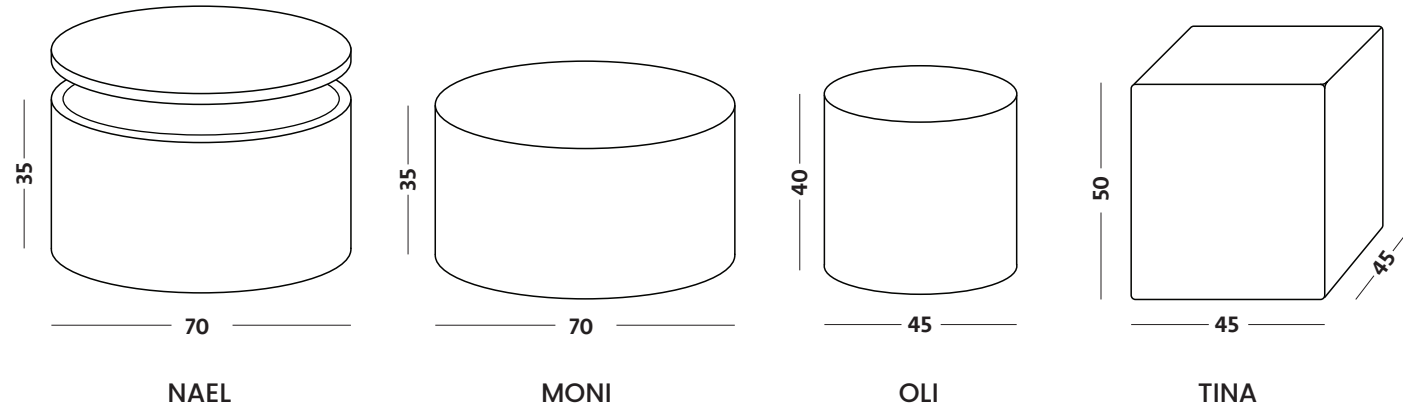



BOUDOIR BREEZE

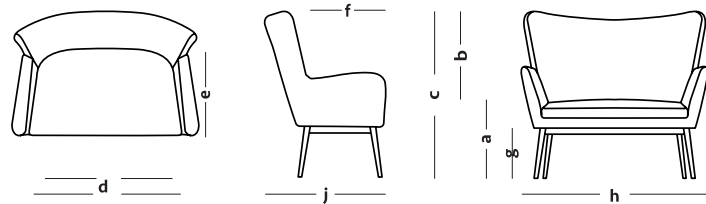

	a	b	c	d	e	f	g	h	j	(cm)
CROSS	45	53	98	116 100	56	54	31	140	84	

BREEZE

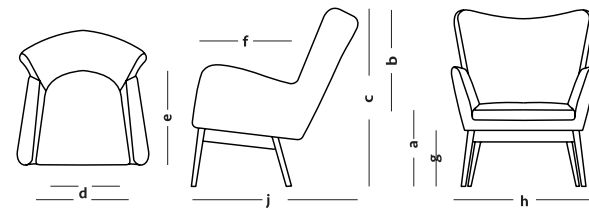

	a	b	c	d	e	f	g	h	j	(cm)
CUT	45	63	94	56 42	56	42	26 31	78	85	
CROSS	45	63	102	56 42	56	42	32	78	80	

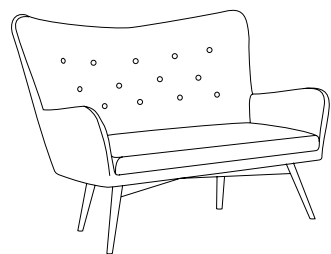

Button

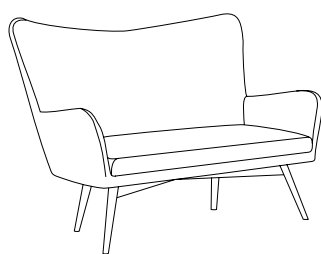

Clean

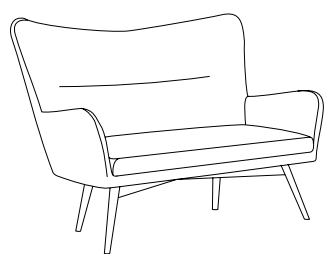

Mirach

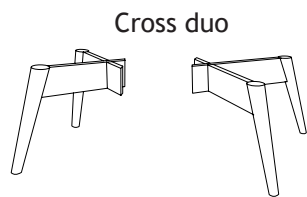

Cross duo

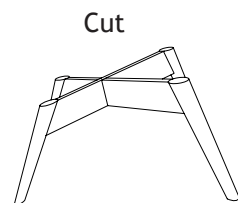

Cut

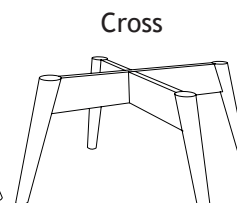

Cross

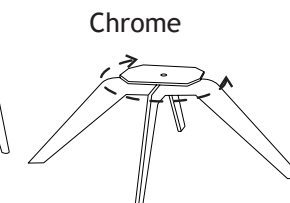

Chrome

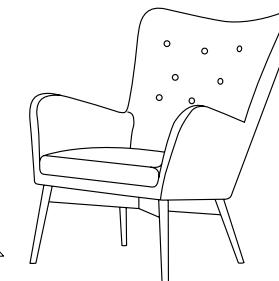

Button

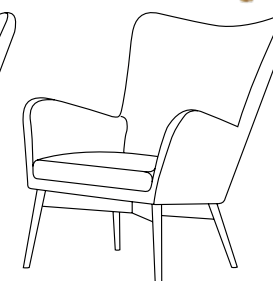

Clean

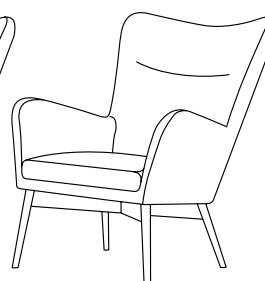

Mirach



DE LUXE

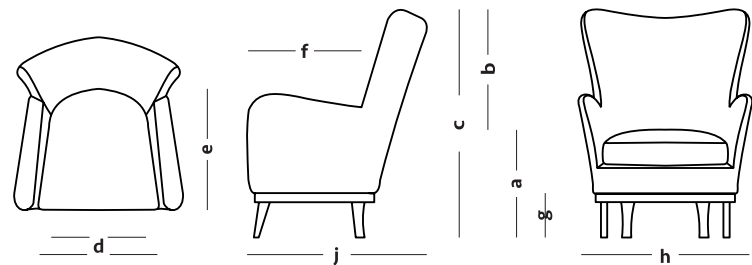

	a	b	c	d	e	f	g	h	j	(cm)
CASTEL	45	55	100	56 42	54	49	20	79	80	
LINE	46	55	101	56 42	54	49	21	79	80	

MODERN

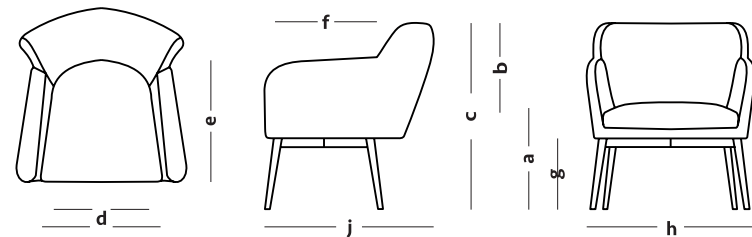

	a	b	c	d	e	f	g	h	j	(cm)
CUT	45	33	69	55 44	56	42	26 31	75	79	
CROSS	45	33	78	55 44	56	42	32	75	75	

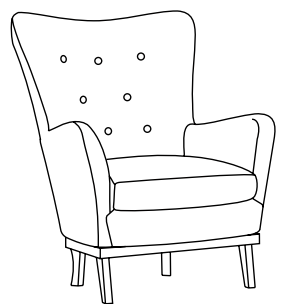

Button

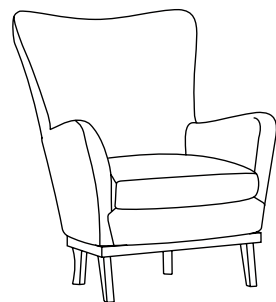

Clean

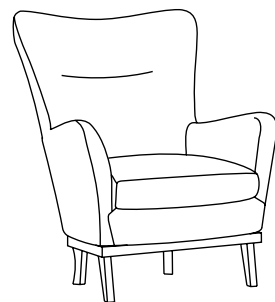

Mirach

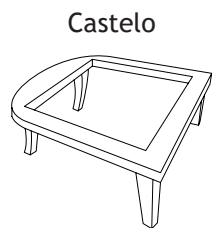

Castelo

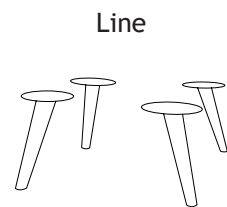

Line

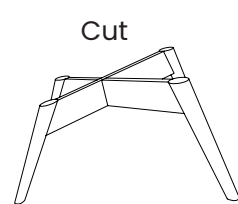

Cut

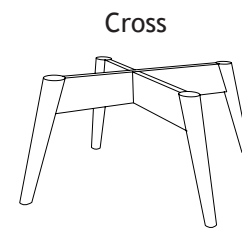

Cross

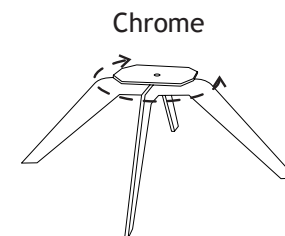

Chrome

CUT

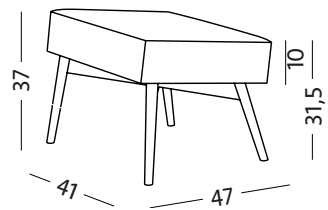

CASTELO

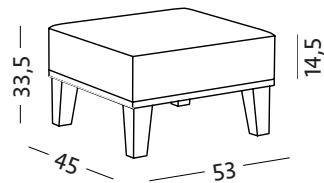

CROSS

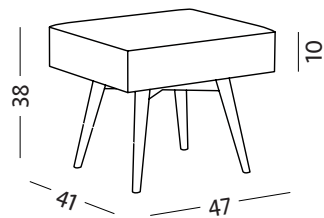

DAMIANI SWISS

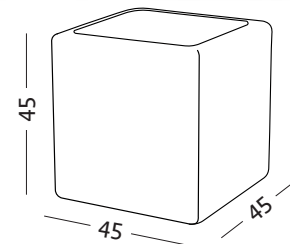

VITO DARK / LIGHT

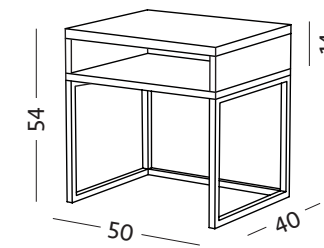

PIETRO DARK / LIGHT

NEW

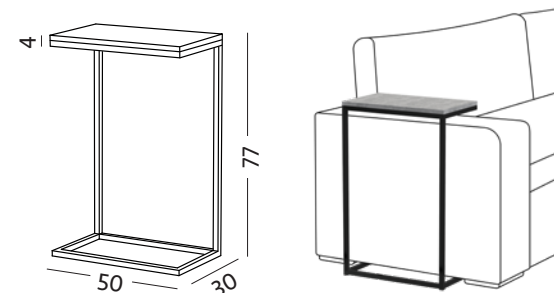

NEW

NIMO

DARK / LIGHT

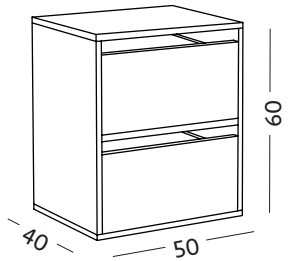

VITORIO U

DARK / LIGHT

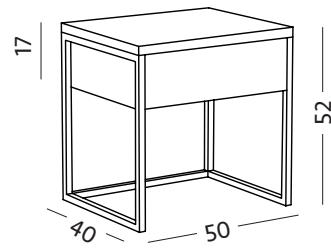

VITORIO L

DARK / LIGHT

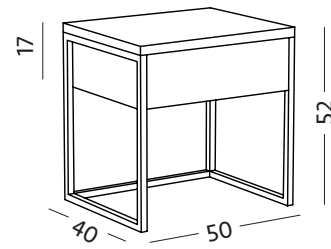

ANA

DARK / LIGHT

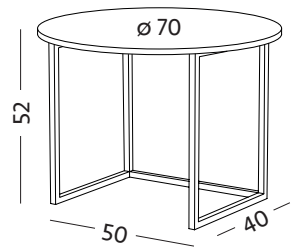

ANITA

DARK / LIGHT

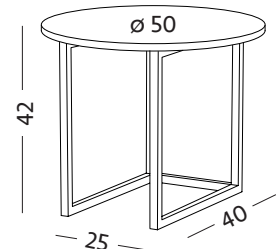

NEW



DARK

LIGHT

INDUSTRY

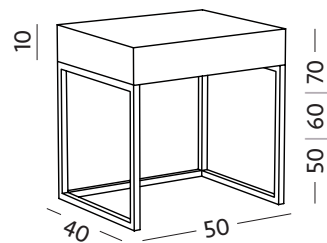

HEAVY OAK

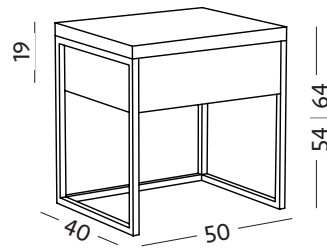

OAK

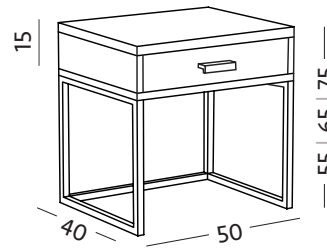

DAMIANI

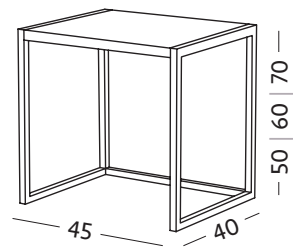

CUBE

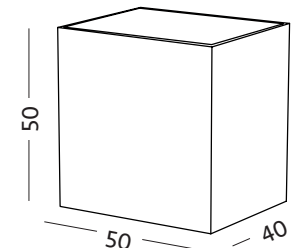

LA SPEZIA

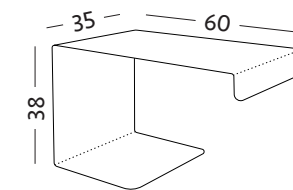

TABURET | BENCH

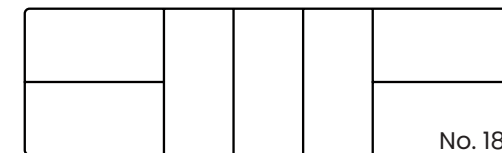
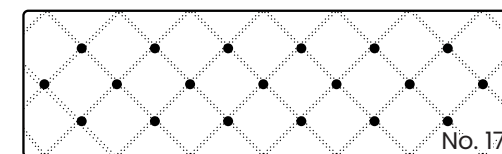
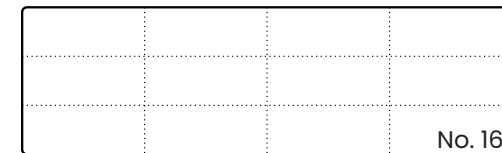
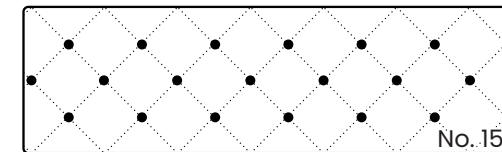
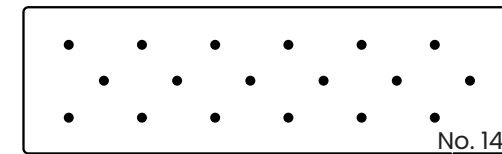
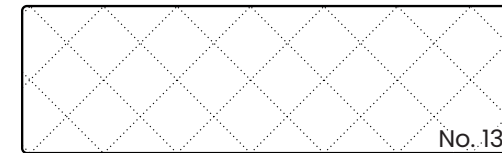
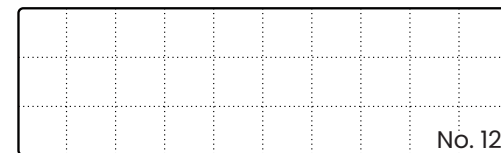
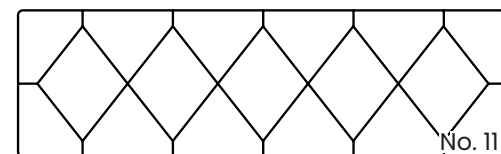
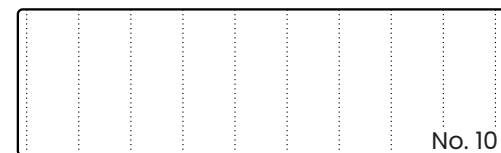
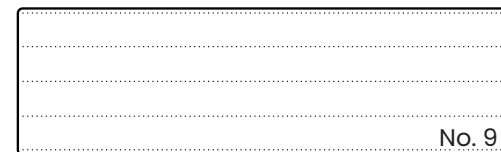
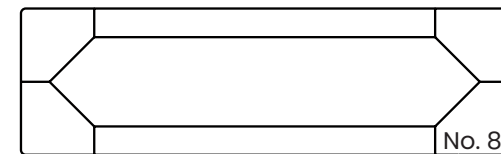
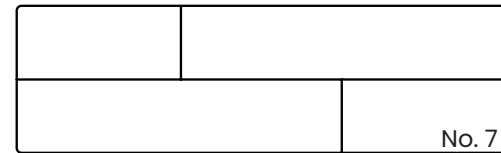
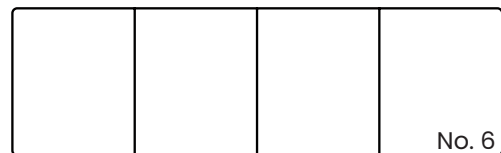
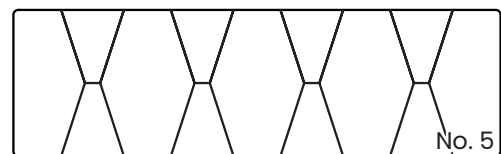
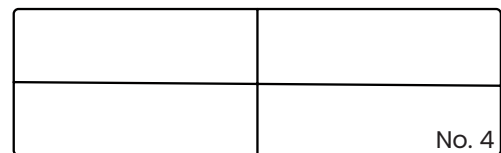
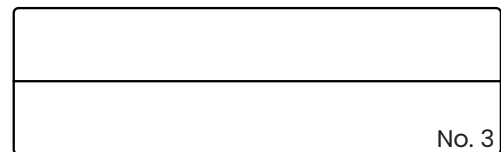
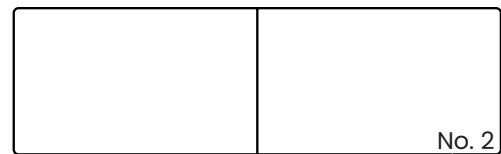
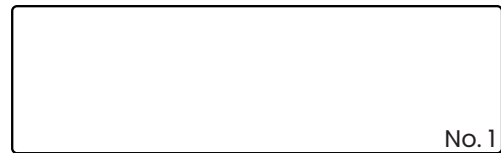
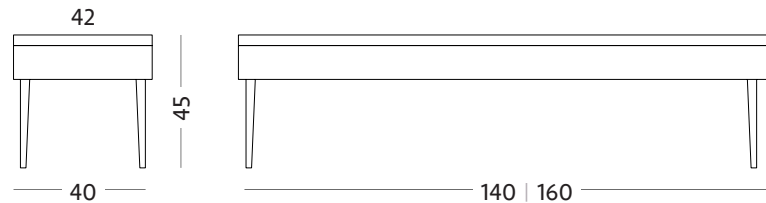
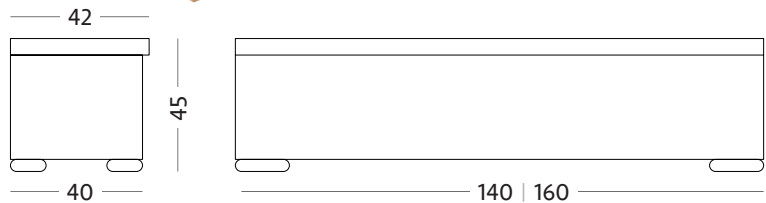

NEW



Flute

120 | 150 | 190 mm - black, bronze, chrome, gold

NEW



Line

120 | 150 | 220 mm - chrome, black, white

NEW



Light

150 mm - black

NEW



Floor angle

200×200×20 mm - chrome

NEW



Floor tube

200 mm × 32 mm - chrome



Floor

150×150×30 mm - chrome

NEW



Capri

200 mm - black | 190 mm - chrome

NEW



Dual

150 mm - black

NEW



Spider

120 | 150 mm - chrome

NEW



Fancy

130 mm - chrome



Industry

130 mm - black

NEW



Elegance

130 mm - black, white, chrome, gold



Polygon

100 mm - chrome



Metal

80 mm - chrome



Block ·

100 | 130 | 160 mm – natur, walnut, gray, wenge, black



Wood 1

88 | 100 | 130 mm – natur, gray, walnut, wenge, black



Tulip

130 mm – natur



Castello

130 mm – walnut



Cube

100 mm – cherry



Wood 2

80 mm – natur, walnut, gray, wenge, black



Wood 4

110 mm – natur, walnut, gray, wenge, black



Wood 5

110 mm – natur, walnut, gray, wenge, black

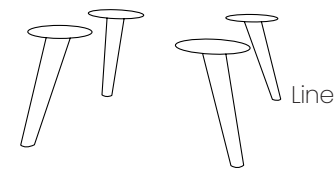

Line

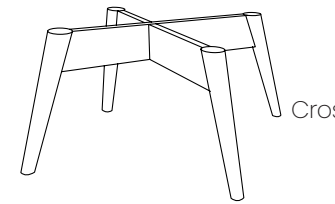

Cross

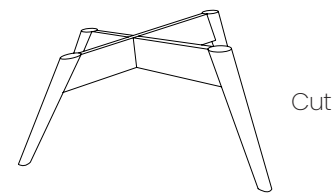

Cut

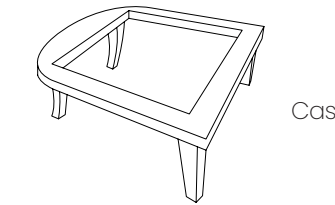

Castello

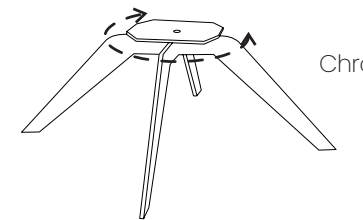

Chrome



Natur

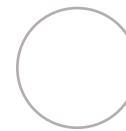

White



Walnut

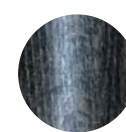

Wenge



- SK** Obsah katalógu je duševným vlastníctvom firmy MATERASSO Slovakia, s.r.o. Použití tieto materiály je možné len s uvedením ich vlastníka: © MATERASSO Slovakia, s.r.o. Nedodržanie týchto podmienok je právne **vymáhateľné ako porušenie autorských práv**. Farby použitých materiálov sú ilustračné, môžu byť odlišné od skutočnosti.
- CZ** Obsah katalogu je duševním vlastnictvím firmy MATERASSO Slovakia, s.r.o. Použití tyto materiály lze pouze s uvedením jejich vlastníka: © MATERASSO Slovakia, s.r.o. Nedodržení těchto podmínek je právně **vymáhateľné jako porušení autorských práv**. Barvy použitých materiálů jsou ilustrační, mohou být odlišné od skutečnosti.
- EN** The content of the catalogue is the intellectual property of MATERASSO Slovakia, s.r.o. It is possible to use these materials only with the indication of their owner: © MATERASSO Slovakia, s.r.o. Failure to comply with these terms and conditions is legally **enforceable as copyright infringement**. The colors of the materials used are illustrative, they may differ from the actual ones.
- PL** Zawartość katalogu jest własnością intelektualną MATERASSO Slovakia, s.r.o. Korzystanie z tych materiałów jest możliwe tylko za wskazaniem ich właściciela: © MATERASSO Slovakia, s.r.o. Nieprzestrzeganie tych warunków jest prawnie **egzekwowalne jako naruszenie praw autorskich**. Kolory użytych materiałów mają charakter poglądowy, mogą różnić się od rzeczywistych.
- HU** A katalógus tartalma a MATERASSO Slovakia, s.r.o. szellemi tulajdonát képezi. Ezeket az anyagokat csak a tulajdonos feltüntetésével lehet felhasználni: © MATERASSO Slovakia, s.r.o. E feltételek be nem tartása jogilag **érvényesíthető szerzői jogsértésként**. A felhasznált anyagok színei illusztrációs célokat szolgálnak, és eltérhetnek a valóságtól.
- DE** Der Inhalt des Katalogs ist geistiges Eigentum von MATERASSO Slovakia, s.r.o. Die Nutzung dieser Materialien ist nur mit Angabe des Eigentümers möglich: © MATERASSO Slovakia, s.r.o. Die Nichteinhaltung dieser Bestimmungen und Bedingungen kann als **Urheberrechtsverletzung rechtlich verfolgt werden**. Die Farben der verwendeten Materialien sind illustrativ, sie können von den tatsächlichen abweichen.

m
Materasso
www.materasso.sk
2026

